

ISA-E5

SINGLE BOARD COMPUTER

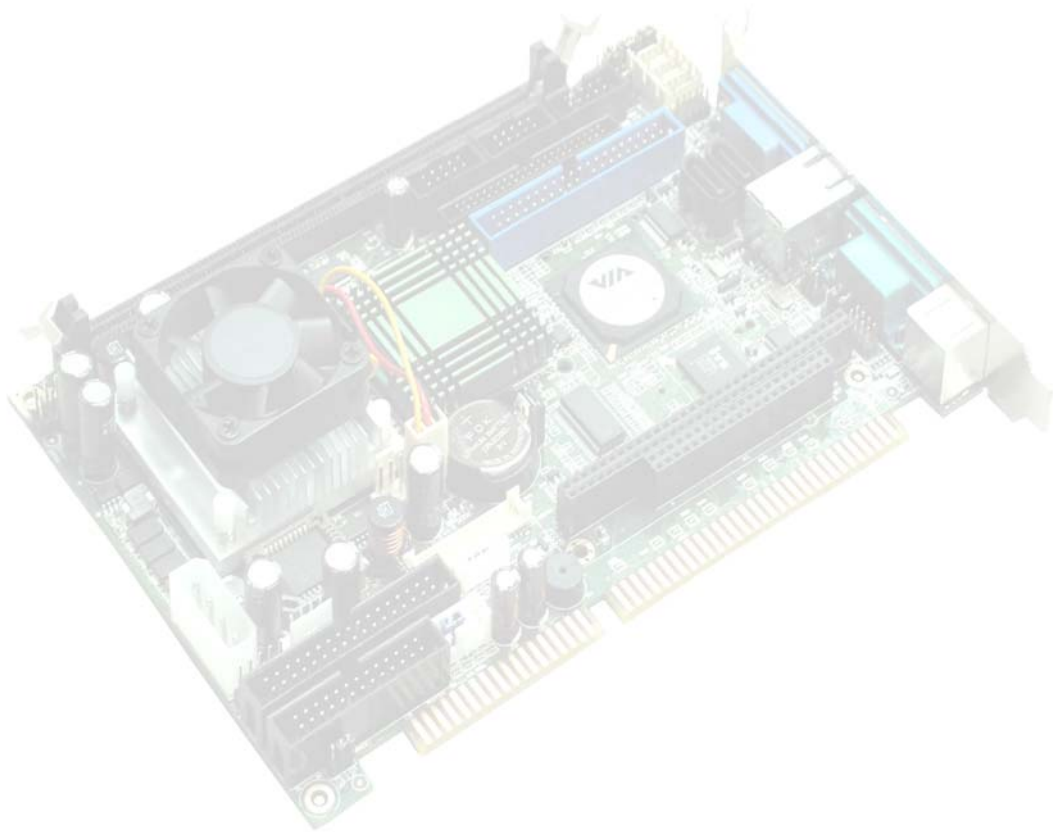

User`s Manual

Version 1.0

Copyright Notice

This publication is protected by copyright and all rights are reserved. No part of it may be reproduced or transmitted by any means or in any form, without prior consent of the original manufacturer.

The information in this document has been carefully checked and is believed to be accurate. However, the original manufacturer assumes no responsibility for any inaccuracies that may appear in this manual. In no event will the original manufacturer be liable for direct, indirect, special, exemplary, incidental, incidental or consequential damages resulting from any defect or omission in this manual, even if advised of possibility of such damages. The material contained herein is for informational purposes only.

Acknowledgments

Award is a registered trademark of Award Software International, Inc. IBM, PS/2 are trademarks of International Business Machines Corporation.

Intel, Pentium4 are registered trademarks of Intel Corporation.

Microsoft Windows is a registered trademark of Microsoft Corporation.

All other product names or trademarks are properties of their respective owners.

Contents

Introduction	1
Chapter 1 Features & Specifications	2
Features	3
Specifications.....	4
Chapter 2 Jumper setting & Connectors.....	9
Jumpers on the ISA-E5	10
Jumper Locations on the ISA-E5.....	11
JP1, JP2: COM Power Selection	12
JP3: Clear CMOS RAM Data.....	12
JP4: LCD PANEL Power Selection	12
JP5: CF Card Mode Selection	13
COM2MODE1: RS232/RS422/RS485 Protocol Selection	13
PWRMODE: AT Mode Selection	14
Connectors on the ISA-E5	15
Connector Locations on the ISA-E5.....	16
Front Panel Connector	17
BACKLIGHT Connector	18
IrDA Connector	19
SATA1, SATA2 Connectors	19
EIDE Connectors.....	20
COM1 Serial Port	22
COM2 Serial Port	22
COM3, COM4 Serial Ports	23
USB12, USB34 Connectors	23
Floppy Drive Connector	24
Parallel Port Connector.....	25
PS/2 Keyboard & Mouse Connector	26
VGA Connector.....	26
INT_VGA Connector	27
INT_KBMS Connector	27
AUDIO Connector.....	27
CPU FAN Power Connector.....	28
System FAN Power Connector.....	28
ATX Power Connector	28

PWR_IN1 Connector	30
PWR_IN2 Connector	30
LAN- RJ45 Connector	31
LAN RJ45 LED.....	31
LVDS LCD Connector.....	32
CF-II Connector	33
Chapter 3 BIOS Setup	34
BIOS Introduction.....	35
Starting Setup	35
Using Setup	36
Getting Help	37
In Case of Problems	37
Main Menu.....	38
<i>Standard CMOS Features</i>	<i>38</i>
<i>Advanced BIOS Features</i>	<i>38</i>
<i>Advanced Chipset Features.....</i>	<i>39</i>
<i>Integrated Peripherals</i>	<i>39</i>
<i>Power Management Setup.....</i>	<i>39</i>
<i>PnP / PCI Configurations</i>	<i>39</i>
<i>PC Health Status</i>	<i>39</i>
<i>Frequency/Voltage Control.....</i>	<i>39</i>
<i>Load Fail-Safe Defaults</i>	<i>39</i>
<i>Load Optimized Defaults.....</i>	<i>39</i>
<i>Supervisor / User Password.....</i>	<i>39</i>
<i>Save & Exit Setup.....</i>	<i>39</i>
<i>Exit Without Save</i>	<i>39</i>
Standard CMOS Setup	40
Channel 0 HDDs / Channel 1 HDDs.....	42
Channel 2 HDDs / Channel 3 HDDs.....	44
Drive A / Drive B.....	46
Video	46
Halt On.....	46
Advanced BIOS Features	47
CPU Feature	48
Delay Prior to Thermal.....	48
Thermal Management	48
TM2 Bus Ratio.....	48
TM2 Bus VID	49
Hard Disk Boot Priority	49
Bootable ADD-in Cards.....	49
Virus Warning.....	49

CPU L1 & L2 Cache	50
CPU L2 Cache ECC Checking	50
Quick Power On Self Test	50
First/Second/Third/Other Boot Device	50
Swap Floppy Drive	50
Boot Up Floppy Seek	50
Boot Up NumLock Status	51
Typematic Rate Setting	51
Typematic Rate (Chars/Sec)	51
Typematic Delay (Msec)	51
Security Option	51
MPS Version Control For OS	52
OS Select For DRAM > 64MB	52
Video BIOS Shadow	52
Small Logo (EPA) Show	52
Advanced Chipset Features	53
DRAM Settings	53
DRAM Clock/Drive Control	54
Current FSB Frequency	54
Current DRAM Frequency	54
DRAM Clock	54
DRAM Timing	54
SDRAM CAS Latency [DDR/DDR2]	54
Bank Interleave	54
Precharge to Active(Trp)	55
Active to Precharge(Tras)	55
Active to CMD(Trcd)	55
REF to ACT/REF (Trfc)	55
ACT(0) to ACT(1) (TRRD)	55
AGP & P2P Bridge Control	55
AGP Aperture Size	56
VGA Share Memory Size	56
Direct Frame Buffer	56
Select Display Device	56
Panel Type	56
CPU & PCI Bus Control	56
PCI Master 0 WS Write	57
PCI Delay Transaction	57
Memory Hole	57
System BIOS Cacheable	57
Video RAM Cacheable	57

Init Display First	57
Integrated Peripherals	58
VIA OnChip IDE Device	58
OnChip SATA.....	59
SATA Mode	59
IDE DMA transfer access	59
OnChip IDE Channel0	59
OnChip IDE Channel1	59
IDE Prefetch Mode	59
Primary/Secondary Master/Slave PIO	59
Primary/Secondary Master/Slave UDMA.....	59
IDE HDD Block Mode.....	59
VIA OnChip PCI Device	60
AC97 Audio	60
VIA VT6103 LAN	60
OnChip USB Controller.....	60
OnChip EHCI Controller	60
USB Emulation	60
USB Keyboard Support.....	61
USB Mouse Support	61
SuperIO Device.....	61
Onboard FDC Controller.....	61
Onboard Serial Port 1/Port 2	61
UART Mode Select.....	61
RxD, TxD Active	62
IR Transmission Delay.....	62
UR2 Duplex Mode	62
Onboard Parallel Port.....	62
Parallel Port Mode.....	62
EPP Mode Select.....	62
ECP Mode Use DMA.....	62
PWRON After PWR-Fail.....	62
Onboard Serial Port 3/Port 4/Port 5/Port 6.....	62
Serial Port 3/Port 4/Port 5/Port 6 Use IRQ	62
Watch Dog Timer Select	62
Power Management Setup.....	63
ACPI Function	63
Power Management Option.....	64
HDD Power Down	64
Suspend Mode.....	64
Video Off Option	64

Video Off Method	65
MODEM Use IRQ.....	65
Soft-Off by PWRBTN.....	65
IRQ/Event Activity Detect	65
PS2KB Wakeup from S3/S4/S5	66
PS2MS Wakeup from S3/S4/S5	66
USB Resume from S3	66
VGA	66
LPT & COM.....	66
HDD & FDD	66
PCI Master.....	66
PowerOn by PCI Card	66
Modem Ring Resume	66
RTC Alarm Resume	66
Date (of Month).....	66
Resume Time (hh:mm:ss).....	67
IRQs Activity Monitoring	67
Primary INTR.....	67
IRQ3 (COM 2)	67
IRQ4 (COM 1)	67
IRQ5 (LPT 2)	67
IRQ6 (Floppy Disk).....	68
IRQ7 (LPT 1)	68
IRQ8 (RTC Alarm).....	68
IRQ9 (IRQ2 Redir).....	68
IRQ10 (Reserved).....	68
IRQ11 (Reserved).....	68
IRQ12 (PS/2 Mouse)	68
IRQ13 (Coprocessor).....	68
IRQ14 (Hard Disk)	68
IRQ15 (Reserved).....	68
PnP/PCI Configuration Setup	69
PNP OS Installed.....	69
Reset Configuration Data	69
Resources Controlled By	70
IRQ Resources	70
IRQ-3/IRQ-4/IRQ-5/IRQ-7/IRQ-9/IRQ-10/IRQ-11/IRQ-12 /IRQ-14/IRQ-15 assigned to.....	71
DMA Resources	71
DMA-0/ DMA-1/ DMA-3/ DMA-5/DMA-6/ DMA-7 assigned to	71

PCI/VGA Palette Snoop.....	72
Assign IRQ For VGA.....	72
Assign IRQ For USB	72
PC Health Status	73
CPU Warning Temperature.....	73
Current System Temp.	73
Current CPUDEI Temperature.....	73
Current CPU Temperature	73
Current CPUFAN Speed	74
Current SYSFAN Speed	74
Vcore/1.5V/3.3V/5V/12V/-12V/VBAT/5VSB Voltages... 74	74
Shutdown Temperature	74
CPU Fan Control.....	74
SYSTEM Fan Control.....	74
Frequency/Voltage Control	75
CPU Clock Ratio.....	75
Auto Detect PCI Clk	75
Spread Spectrum	75
Load Fail-Safe Defaults	76
Load Optimized Defaults.....	76
Supervisor/User Password Setting.....	77
Exit Selecting	78
Save & Exit Setup	78
Exit Without Saving.....	78
CHAPTER 4 Appendix.....	79
A. I/O Port Address Map.....	80
B. Interrupt Request Lines (IRQ).....	81
C. POST Beep	82

Introduction

This manual is designed to give you information on the ISA-E5 Single Board Computer card. The topics covered in this manual are as follows:

- ✓ **Features**
- ✓ **Specification**
- ✓ **Jumper setting and Connectors**
- ✓ **BIOS Setup**
- ✓ **Appendix**

Chapter 1

Features & Specifications

Features	3
Specifications	4

Features

- Support both VIA C7 and EDEN NanoBGA2 CPU in V4 bus for either High performance or Low Power.
- Compact design with Rich I/O functions for Panel PC, Thin-client terminal, Automation.
- Multiple I/O support, up to four USB2.0 ports and four COM ports. COM1, COM2 can be powered by either 5V or 12V.
- Support LVDS LCD up to dual 24-bits channel. The resolution can be up to 1600x1200. Dual Independent display and rotation supported by Drivers.
- Dedicated LCD inverter connector with LCD Brightness control by software. Software ready for Windows XP/2K.
- Single 10/100M LAN Design with Remote Boot and Wake Up on LAN support.
- AC97 3D Audio Codec on board with internal connection for Line-OUT, Line-IN and Microphone.
- Support versatile storage devices: 3.5”HDD, 2.5”HDD, DOM module in 40pins and 44pins.
- COM2 supports RS232/422/485, selectable by jumpers.
- Dual SATA-I ports, support IDE mode, RAID0 and RAID1.
- Half-Size ISA Bus CPU card, while with Power connector and four screw holes for standalone operation.
- Bundle Low noise CPU cooler for C7 1.5GHz or higher speed CPU. FANLESS CPU heat sink available for EDEN 1.0GHz or lower speed CPU.
- PC104-ISA socket and four mounting holes for Standard PC104 module support.
- One Compact Flash Socket for CF Flash Card support.

Specifications

- **Processor Support:**
 - VIA nanoBGA2 V4 interface CPU mounted on board.
 - Support VIA C7 High performance CPU 1.5G, 1.6G, 1.8G and 2.0GHz.
 - Support VIA EDEN (V4) Low Power CPU 400M, 500M, 600M, 800M, 1.0G, 1.2G, 1.5GHz.

- **Major Chipset:**
 - VIA CN700 and VT8237RPlus chipset.
 - VIA VT6103L LAN chip.
 - Winbond 83627HF Super I/O.
 - ALC655 AC97 Audio chip.

- **System Memory:**
 - One DDR DIMM 184-pins Socket support DDR 266/333/400 unregistered non-ECC up to 1.0 GB.

- **Video Controller:**
 - CN700 Integrated S3 Graphic Engine.
 - One 15-Pins D-Sub Female connector on external I/O ports for CRT Displays.
 - One 40-pins connector for Dual 18/24-bits LVDS LCD displays.
 - One 5-pins JST connector for Inverter power and brightness control.

- **Super I/O:**
 - Winbond 83627HF LPC I/F Super I/O chip.
 - Four COM ports: One D-Sub connector on external I/O ports and three in 2x5 box-header, support standard RS-232 protocols. Dual COM ports or single COM port cable with mounting bracket enclosed for external COM ports access.
 - COM1 and COM2 Pin9 are powered with either 5V or 12V or Ring-In selected by Jumpers.
 - COM2 are RS232/422/485 selectable by jumpers.
 - 1 x Parallel port supports SPP/ECP/EPP mode.
 - 1 x IrDA port.
 - 1x standard 34-pins FDD connector.
 - Four USB2.0 ports with 2x5 box-header. Dual USB ports cable with mounting bracket enclosed for external USB

-
- devices.
 - 1 x PS2 Keyboard/mouse connector with Mini-DIN 6-pins on external I/O ports. Y-cable enclosed for both Keyboard and Mouse access.
 - **Hardware Monitor:**
 - 83627HF integrated hardware monitor chip to monitor Voltages, Temperatures and FAN speed.
 - Temperature Monitor: CPU thermal diode, one sensor close to CPU socket, one sensor close to 83627HF chip.
 - One CPU FAN for CPU cooler and one SYS FAN for chassis FAN. All FAN speed are monitored and can be controlled by CPU and System temperature to turn-on or turn-off.
 - **10/100M Ethernet:**
 - One VIA VT6103L on board for 10/100M LAN.
 - Support Wake Up-on-LAN.
 - The LAN connector is RJ45 connector on external I/O ports. RJ45 connector with Link, Activity and Speed LED indicators.
 - Remote Boot Agent is supported with PXE and RPL protocol.
 - **PIDE and SATA:**
 - PIDE controller build in VT8237 support up to UltraDMA mode 6 or ATA133 speed.
 - One standard 40-pins box header to support 3.5" HDD, CDROM, DVD player or DOM Flash Disk.
 - One standard 44-pins box-header support 2.5" HDD, Slim CD-ROM or DOM Flash Disk.
 - One Compact Flash-II socket share with Secondary IDE Channel. Jumper selectable as Master or Slave device.
 - Two SATA connectors from VT8237R support SATA-I and SATA-II devices. Two SATA HDDs can be configured as RAID0 or RAID1 through Option- ROM or Windows Utilities.
 - **Watchdog Timer:**
 - The disable/enable selection can be programmed in BIOS setup. The timeout interval can be set up through programmed I/O address 300h/301h.
 - The timeout event will generate the RESET.
 - **CMOS:**
 - On-board RTC with 242 bytes of Battery-back CMOS RAM.
 - One 3-pins Jumper/2mm to clear CMOS data.

-
- **Audio:**
 - RealTek ALC655 AC97 Audio chip on-board.
 - One 10-pins pin-header to provide internal audio device connection.
 - Support Line-Out, Line-In and Microphone.

 - **BIOS:**
 - Award Standard PnP Flash BIOS 6.0.
 - 4Mbit FlashROM with BootBlock for Fail-safe.
 - BIOS utility for field update.
 - VBIOS for LCD panel support and LAN remote BootROM integrated.

 - **Power Connector:**
 - Support both AT mode or ATX mode operation.
 - One 4-pins connector to supports ATX 5VSB power and ATX ON/OFF control signals.
 - Supply +5V and +12V output power with 4-pins 3.5" FDD type 4-pins power connector.
 - Support standalone operation with Standard 3.5" HDD type 4-pins power connector.

 - **Software Compatibility:**
 - Microsoft windows: NT4.0, Win XP, Win 2K Prof, Win2K Server, Win2003, .NET.
 - Linux RedHat 7.2, 7.3, 8.0, 9.0.
 - DOS 6.0 and 6.22.
 - QNX v6.2, WinCE 5.0.

 - **Cooling:**
 - Two cooling FAN connectors close to CPU for CPU cooler and System FAN.
 - Flat Heat-sink on top of CN700 and VT8237R chipset.
 - Customized Cooler for VIA nanoBGA2 CPU.
 - FANLESS CPU heat sink available for EDEN 1.0GHz or lower speed CPU.
 - Low noise CPU cooler for C7 1.5GHz or higher speed CPU.

 - **Others:**
 - One Buzzer (9mm) on-board for beep message.

 - **Operating Temperature:**
 - 0~50°C Operation Range.
 - Relative Humidity: 5~95%, non-condensing.

-
- **Dimensions:**
 - 185mm(W) x 127mm(L)
 - 4 screw holes on four corners.

This page is intentionally left blank.

Chapter 2

Jumper setting & Connectors

Jumpers on the ISA-E5.....	10
Connectors on the ISA-E5.....	15

Jumpers on the ISA-E5

The jumpers on the ISA-E5 allow you to configure your Single Board Computer card according to the needs of your applications. If you have doubts about the best jumper configuration for your needs, contact your dealer or sales representative. The following table lists the jumpers on ISA-E5 and their respective functions.

- Jumper Locations on the ISA-E5 11
- JP1, JP2: COM Power Selection 12
- JP3: Clear CMOS RAM Data 12
- JP4: LCD PANEL Power Selection 12
- JP5: CF Card Mode Selection 13
- COM2MODE1: RS232/RS422/RS485 Protocol Selection 13
- PWRMODE: AT Mode Selection..... 14

Jumper Locations on the ISA-E5

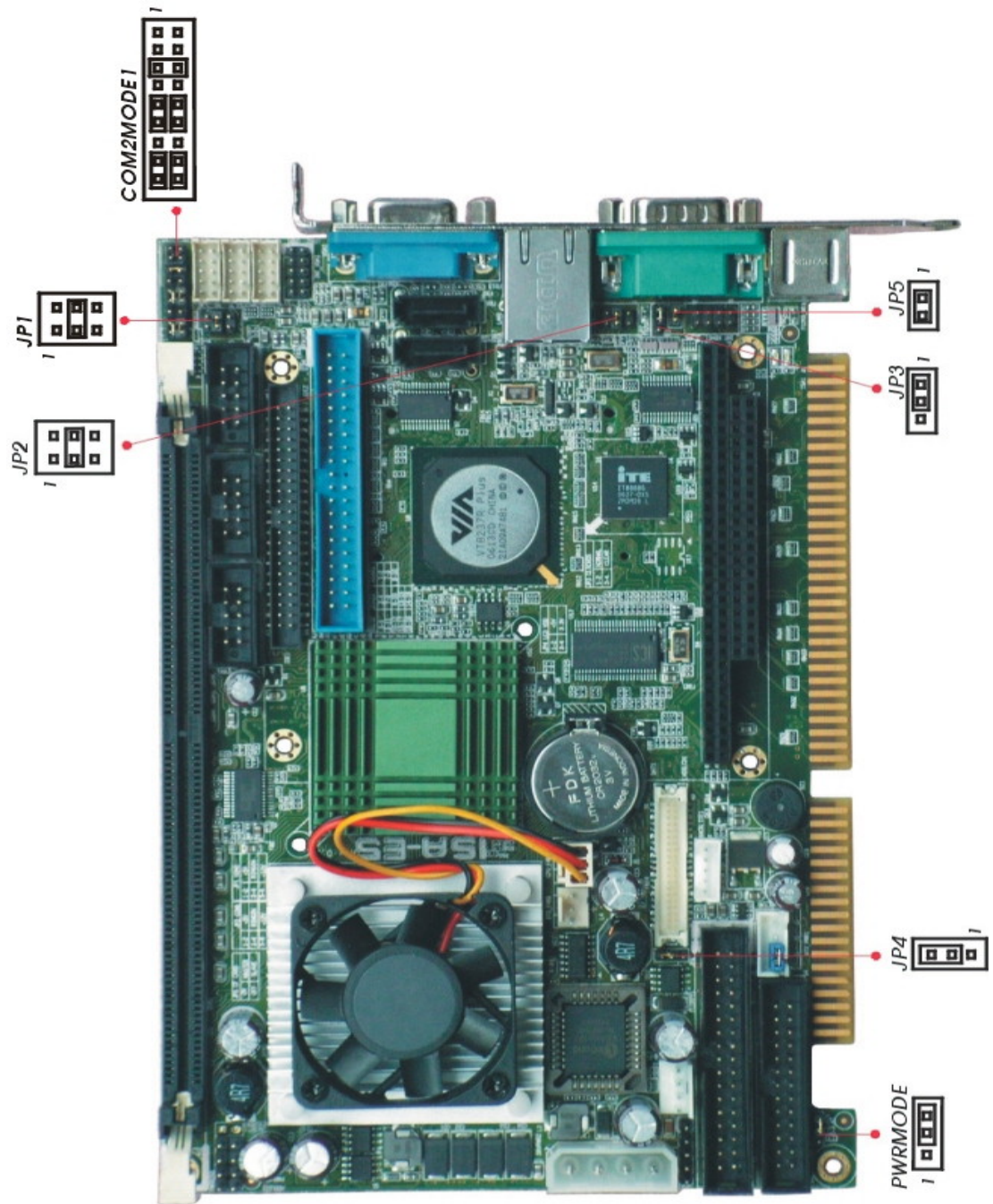

JP1, JP2: COM Power Selection

JP1, JP2 can be used to select the COM supply power: +5V, Ring-IN or +12V.

JP1: COM2 Pin9 power or Ring-IN

JP2: COM1 pin9 power or Ring-IN

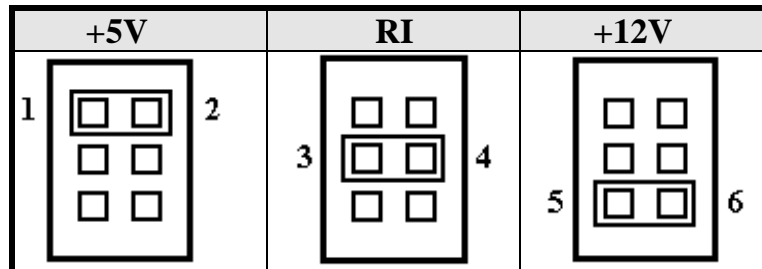

JP3: Clear CMOS RAM Data

This 3-pin Jumper allows the user to disconnect the built-in 3V battery power to clear the information stored in the CMOS RAM. To clear the CMOS data: (1) Turn off the system power, (2) Remove Jumper cap from pin1&2, (3) Short the pin2 and pin3 for three seconds, (4) Put Jumper cap back to pin1 & 2. (5) Turn on your computer, (6) Hold Down <Delete> during boot up and enter BIOS setup to enter your preferences.

JP3	Setting	Function
	Pin 1-2 Short/Closed	Normal Operation (default)
	Pin 2-3 Short/Closed	Clear CMOS Content

JP4: LCD PANEL Power Selection

JP4 can be used to select the Panel LCD supply power: +3.3V or +5V. The default setting is on +3.3V. User need to check the LCD panel spec and adjust this jumper to make Panel work in specified power rail.

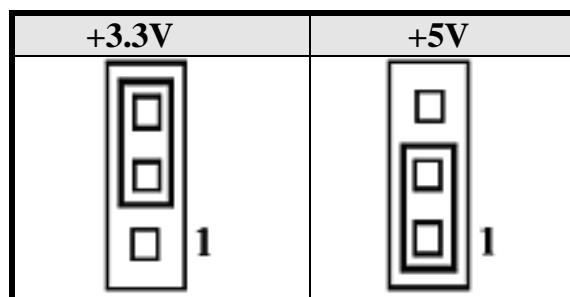

JP5: CF Card Mode Selection

This Jumper is to select the CF works as Primary Channel Master device or Slave device.

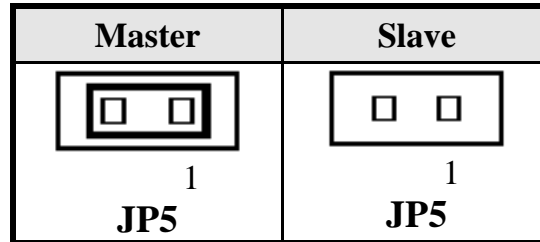



COM2MODE1: RS232/RS422/RS485 Protocol Selection

COM2 supports multi-protocols, includes RS232, RS422 and RS485, while COM1, COM3, COM4 support diffused RS232 protocol.

The Protocols of COM2 can be set up through jumpers.

COM2MODE1: COM2 Protocols selection.

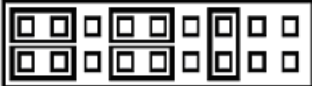
The pin-out for each mode is illustrated on next chapter.

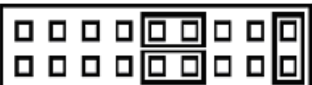
COM2MODE1	I/F TYPE
17 1 	RS-232
18 2 	RS-422
17 1 	RS-485
18 2	

PWRMODE: AT Mode Selection

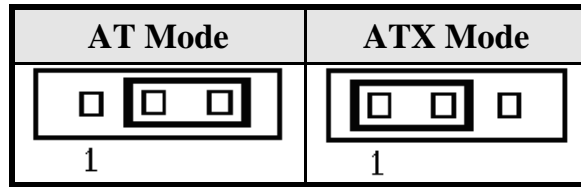

When PWRMODE are chosen as AT Mode, please make sure short Pin3 & Pin4 of ATX-PWR. The setting is illustrated as below :

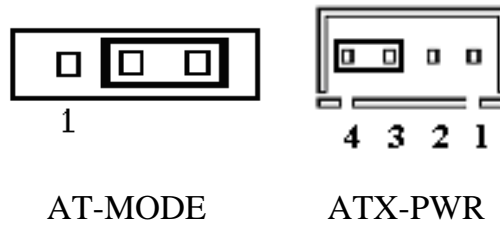

When PWRMODE are chosen as ATX Mode, you will need a cable to connect control signal and 5VSB standby power from backplane to ATX-PWR connector on ISA-E5. In the mean time, you will need to short Pin1 & Pin2 on PWRMODE selection jumper.

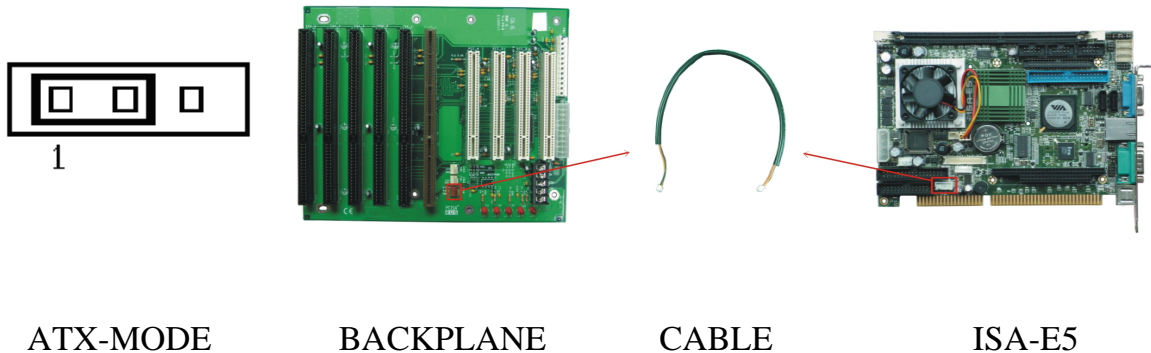

Connectors on the ISA-E5

The connectors on the ISA-E5 allow you to connect external devices such as keyboard, floppy disk drives, hard disk drives, printers and etc. The following table lists the connectors on ISA-E5 and their respective page number.

Connector Locations on the ISA-E5	16
Front Panel Connector.....	17
BACKLIGHT Connector	18
IrDA Connector.....	19
SATA1, SATA2 Connectors.....	19
EIDE Connectors	20
COM1 Serial Port.....	22
COM2 Serial Port.....	22
COM3, COM4 Serial Ports	23
USB12, USB34 Connectors	23
Floppy Drive Connector.....	24
Parallel Port Connector	25
PS/2 Keyboard & Mouse Connector	26
VGA Connector	26
INT_VGA Connector.....	27
INT_KBMS Connector	27
AUDIO Connector	27
CPU FAN Power Connector	28
System FAN Power Connector	28
ATX Power Connector.....	28
PWR_IN1 Connector	30
PWR_IN2 Connector	30
LAN- RJ45 Connector	31
LAN RJ45 LED	31
LVDS LCD Connector.....	32
CF-II Connector	33

Connector Locations on the ISA-E5

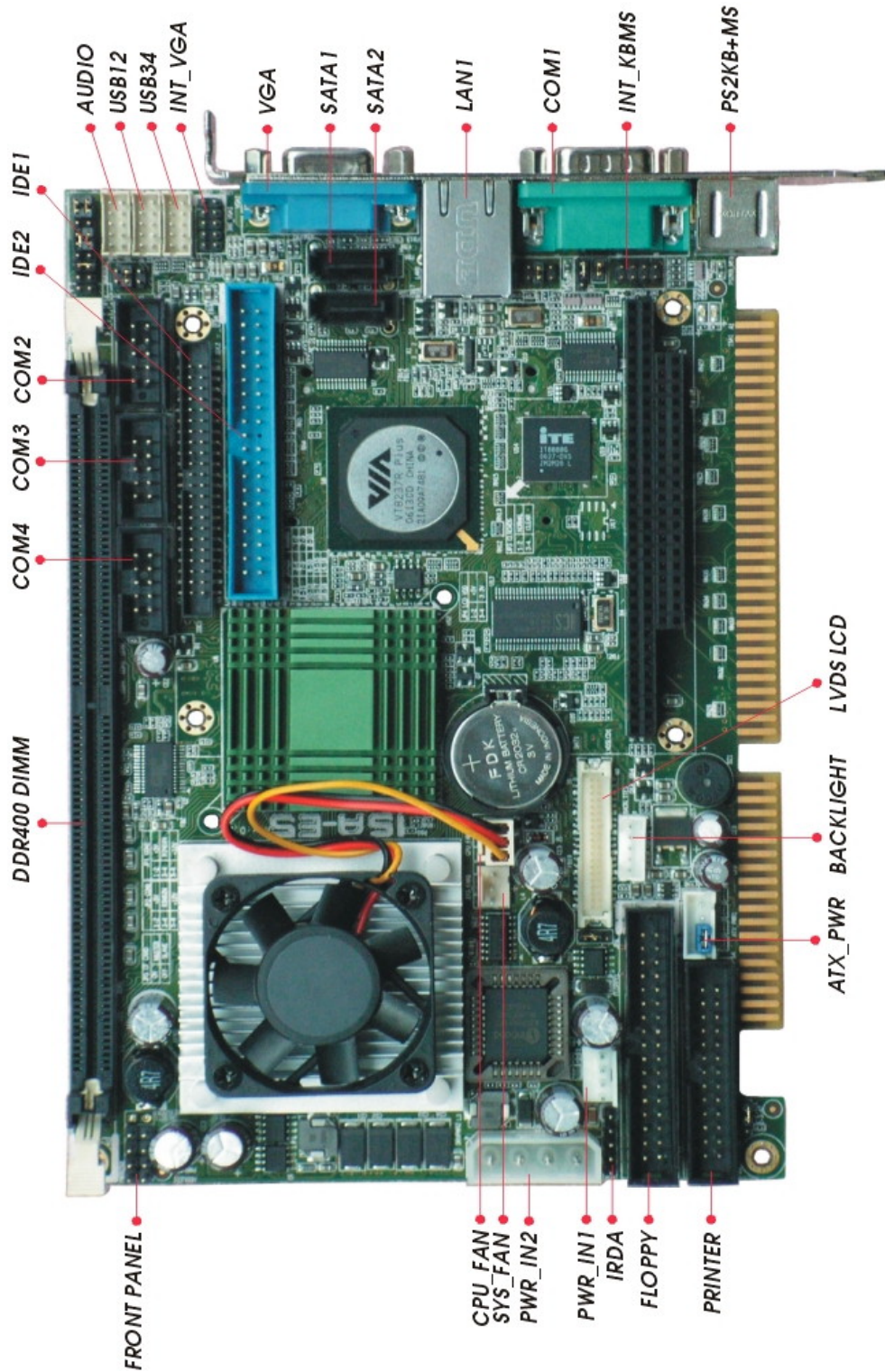

Front Panel Connector

The front panel of the case has a control panel, which provides light indication of the computer activities and switches to change the computer status.

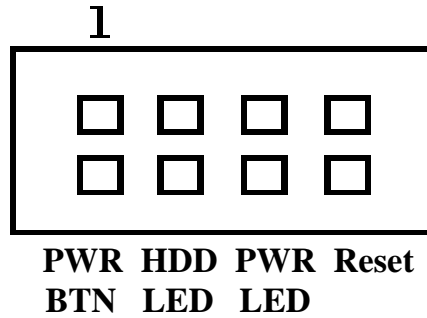

➤ ATX Power ON/OFF Button

This 2-pins connector acts as the “Power Supply On/Off Switch” on the ISA-E5 single board computer card. When pressed, the switch will force the single board computer card to power on. When pressed again, it will force the single board computer card to power off.

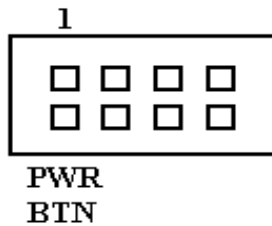

PWR BTN Pin #	Signal Name
1	5VSB
2	PWRBTN

➤ IDE Hard Disk LED Connector

This connector connects to the hard drive activity LED on control panel. This LED will flash when the HDD is being accessed.

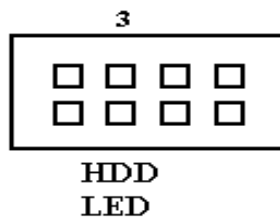

IDE LED Pin #	Signal Name
3	VCC
4	HDDLED

➤ **Power-On LED**

This connector allows users to connect to Front Panel Power indicator.

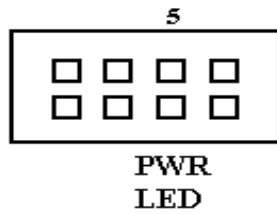

PWR LED Pin #	Signal Name
5	PWRLED
6	Ground

➤ **RESET Switch**

The reset switch allows the user to reset the system without turning the main power switch off and then on. Orientation is not required when making a connection to this header.

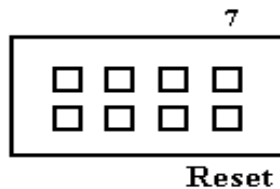

RESET Pin #	Signal Name
7	SYS_RST
8	Ground

BACKLIGHT Connector

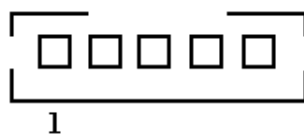

Pin #	Signal Name
1	+12V
2	GND
3	Brightness
4	ON/OFF
5	GND

IrDA Connector

This connector is used for an IrDA connector for wireless communication.

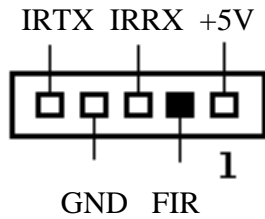

IrDA Pin #	Signal Name
1	+5V
2	FIR
3	Ir RX
4	Ground
5	Ir TX

SATA1, SATA2 Connectors

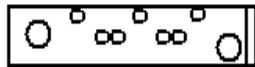

1 7

Pin #	Signal Name
1	GND
2	SATARX+
3	SATARX-
4	GND
5	SATATX-
6	SATATX+
7	GND

EIDE Connectors

Primary IDE Connector

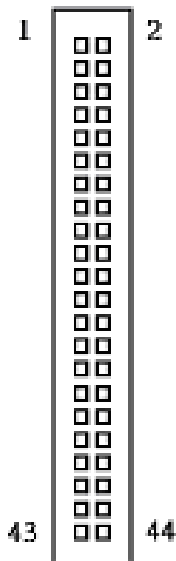

Signal Name	Pin #	Pin #	Signal Name
Reset IDE	1	2	Ground
Host data 7	3	4	Host data 8
Host data 6	5	6	Host data 9
Host data 5	7	8	Host data 10
Host data 4	9	10	Host data 11
Host data 3	11	12	Host data 12
Host data 2	13	14	Host data 13
Host data 1	15	16	Host data 14
Host data 0	17	18	Host data 15
Ground	19	20	Key
DRQ0	21	22	Ground
Host IOW	23	24	Ground
Host IOR	25	26	Ground
IOCHRDY	27	28	Host ALE
DACK0	29	30	Ground
IRQ14	31	32	No connect
Address 1	33	34	P66DET
Address 0	35	36	Address 2
Chip select 0	37	38	Chip select 1
Activity	39	40	Ground
+5V	41	42	+5V
GND	43	44	No connect

Secondary IDE Connector

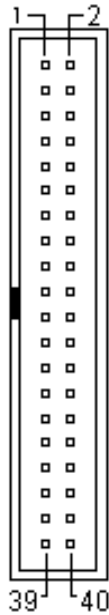

Signal Name	Pin #	Pin #	Signal Name
Reset IDE	1	2	Ground
Host data 7	3	4	Host data 8
Host data 6	5	6	Host data 9
Host data 5	7	8	Host data 10
Host data 4	9	10	Host data 11
Host data 3	11	12	Host data 12
Host data 2	13	14	Host data 13
Host data 1	15	16	Host data 14
Host data 0	17	18	Host data 15
Ground	19	20	Key
DRQ1	21	22	Ground
Host IOW	23	24	Ground
Host IOR	25	26	Ground
IOCHRDY	27	28	Host ALE
DACK1	29	30	Ground
IRQ15	31	32	No connect
Address 1	33	34	S66DET
Address 0	35	36	Address 2
Chip select 0	37	38	Chip select 1
Activity	39	40	Ground

COM1 Serial Port

COM1, a 9-pin D-Sub male connector, is the onboard COM1 serial port of the ISA-E5. The following table shows its pin assignments.

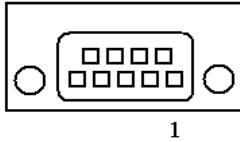

Pin #	RS232 Mode Signal Name
1	DCD, Data carrier detect
2	RXD, Receive data
3	TXD, Transmit data
4	DTR, Data terminal ready
5	GND, ground
6	DSR, Data set ready
7	RTS, Request to send
8	CTS, Clear to send
9	+5V, Ring-IN or +12V

COM2 Serial Port

COM2, a 10-pin header connector, is the onboard COM2 serial port of the ISA-E5. The following table shows its pin assignments while it is configured as RS-232, RS-422 or RS-485 interface.

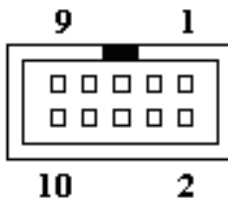

Pin #	RS232 Mode Signal Name	RS422/RS485 Mode Signal Name
1	DCD, Data carrier detect	TX- (422/485)
2	RXD, Receive data	TX+ (422/485)
3	TXD, Transmit data	RX+ (422)
4	DTR, Data terminal ready	RX- (422)
5	GND, ground	GND
6	DSR, Data set ready	N.C.
7	RTS, Request to send	N.C.
8	CTS, Clear to send	N.C.
9	+5V, Ring-IN or +12V	N.C.
10	N.C.	N.C.

COM3, COM4 Serial Ports

COM3, COM4 are 10-pin header connectors, are the onboard COM3, COM4 serial ports of the ISA-E5. The following table shows its pin assignments.

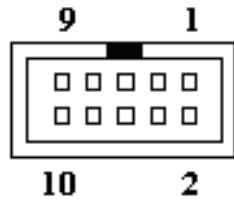

Pin #	RS232 Mode Signal Name
1	DCD, Data carrier detect
2	RXD, Receive data
3	TXD, Transmit data
4	DTR, Data terminal ready
5	GND, ground
6	DSR, Data set ready
7	RTS, Request to send
8	CTS, Clear to send
9	Ring-IN
10	N.C.

USB12, USB34 Connectors

The following table shows the pin outs of the USB12 USB34 connectors.

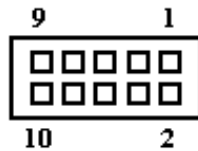

Signal Name	Pin #	Pin #	Signal Name
N.C.	1	2	VCC
GND	3	4	USB-
USB+	5	6	USB+
USB-	7	8	GND
VCC	9	10	N.C.

Floppy Drive Connector

Floppy connector is a 34-pin header and will support up to 2.88MB floppy drives.

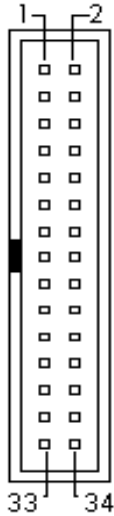

Signal Name	Pin #	Pin #	Signal Name
Ground	1	2	RM/LC
Ground	3	4	No connect
Ground	5	6	No connect
Ground	7	8	Index
Ground	9	10	Motor enable 0
Ground	11	12	Drive select 1
Ground	13	14	Drive select 0
Ground	15	16	Motor enable 1
Ground	17	18	Direction
Ground	19	20	Step
Ground	21	22	Write data
Ground	23	24	Write gate
Ground	25	26	Track 00
Ground	27	28	Write protect
Ground	29	30	Read data
Ground	31	32	Side 1 select
Ground	33	34	Diskette change

Parallel Port Connector

The following table describes the pin out assignments of this connector.

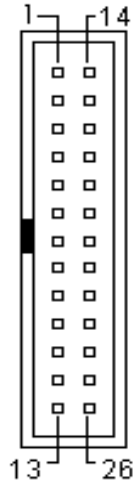

Signal Name	Pin #	Pin #	Signal Name
Line printer strobe	1	14	AutoFeed
PD0, parallel data 0	2	15	Error
PD1, parallel data 1	3	16	Initialize
PD2, parallel data 2	4	17	Select
PD3, parallel data 3	5	18	Ground
PD4, parallel data 4	6	19	Ground
PD5, parallel data 5	7	20	Ground
PD6, parallel data 6	8	21	Ground
PD7, parallel data 7	9	22	Ground
ACK, acknowledge	10	23	Ground
Busy	11	24	Ground
Paper empty	12	25	Ground
Select	13	N/A	N/A

PS/2 Keyboard & Mouse Connector

The following table describes the pin assignment of PS/2 Keyboard and Mouse connector, which is mount on button of bracket. To attach PS/2 Keyboard and mouse, users need to connect trough a PS/2 1-to-2 Y-cable and plug into this Mini-Din connector. All the ISA-E5 boards come with a Y-cable. Contact with your dealer if the Y-cable is missing.

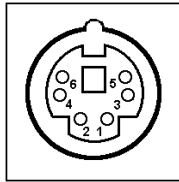

Pin #	Signal Name
1	Keyboard data
2	Mouse data
3	GND
4	5V
5	Keyboard clock
6	Mouse clock

VGA Connector

The pin assignments of VGA CRT connector are as follows:

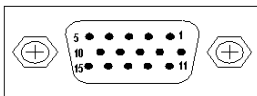

Signal Name	Pin #	Pin #	Signal Name
Red	1	2	Green
Blue	3	4	N.C.
GND	5	6	GND
GND	7	8	GND
N.C.	9	10	GND
N.C.	11	12	DDC_DATA
HSYNC	13	14	VSYNC
DDC_CLK	15		

INT_VGA Connector

INT_VGA is for internal Video A/D board connection. The pin out is listed as below:

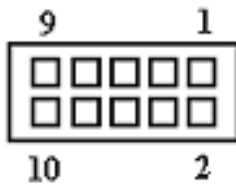

Signal Name	Pin #	Pin #	Signal Name
RED	1	2	GND
GREEN	3	4	GND
BLUE	5	6	GND
HSYNC	7	8	DDC_DATA
VSYNC	9	10	DDC_CLK

INT_KBMS Connector

INT_KBMS is for internal input devices or MSR connection. The pin out is listed as below:

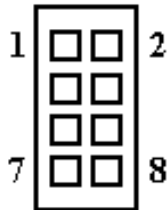

Signal Name	Pin #	Pin #	Signal Name
+5V	1	2	GND
KB-DATA	3	4	MS-CLOCK
KB-CLOCK	5	6	MS-DATA
GND	7	8	+5V

AUDIO Connector

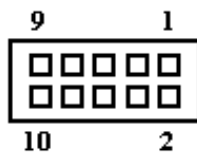

Signal Name	Pin #	Pin #	Signal Name
JD1	1	2	AVDD
MIC2-IN	3	4	MIC1-IN
GND	5	6	GND
LINEOUT-L	7	8	LINE-IN-L
LINEOUT-R	9	10	LINE-IN-R

CPU FAN Power Connector

This is a 3-pin header for the CPU fan.

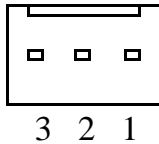

Pin #	Signal Name
1	Ground
2	FANPWR1
3	VCC

System FAN Power Connector

This is a 3-pin header for the System fan.

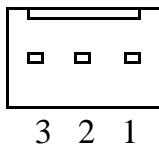

Pin #	Signal Name
1	Ground
2	FANPWR2
3	VCC

ATX Power Connector

This is a four-pin connector to support the ATX power and corresponding back-plane. When your back-plane is configured to perform ATX power supply Soft-on/off function, you have to connect the control signals and stand-by power on this connector to your back-plane by a corresponding cable.

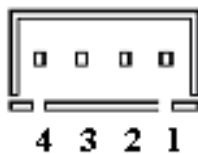

ATX-PWR

Pin #	Signal Name
1	PWR_GD
2	5V_SB (standby +5V)
3	PS-ON (soft on/off)
4	GND

When PWRMODE are chosen as AT Mode, please make sure short Pin3 & Pin4 of ATX-PWR. The setting is illustrated as below :

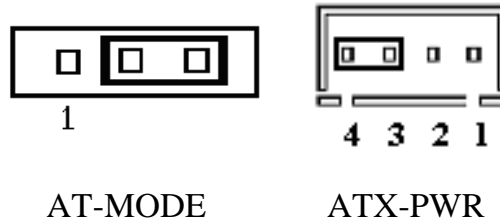

When PWRMODE are chosen as ATX Mode, you will need a cable to connect control signal and 5VSB standby power from backplane to ATX-PWR connector on ISA-E5. In the mean time, you will need to short Pin1 & Pin2 on PWRMODE selection jumper.

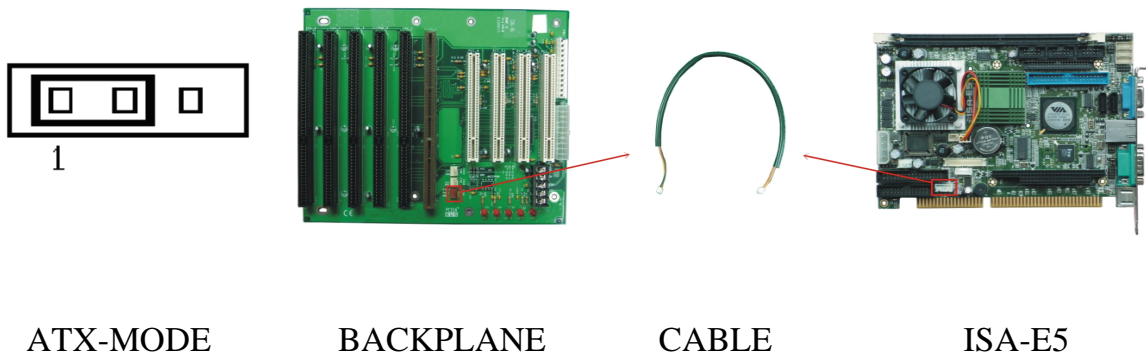

PWR_IN1 Connector

PWR_IN1 is output power connector to supply power required for peripheral devices like Hard Disk, DOM, CDROM and etc.

The pin out is listed as below:

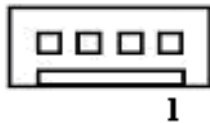

Signal Name	Pin #	Pin #	Signal Name
+5V	1	2	GND
GND	3	4	+12V

PWR_IN2 Connector

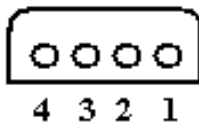

Signal Name	Pin #	Pin #	Signal Name
+12V	1	2	GND
GND	3	4	+5V

LAN- RJ45 Connector

This connector is for the 10/100Mbps Ethernet capability. The figure below shows the pin out assignments of this connector and its corresponding input jack.

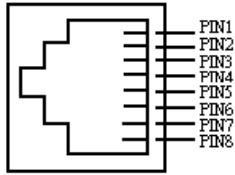

Pin #	Signal Name
1	TX+
2	TX-
3	RX+
4	NC
5	NC
6	RX-
7	NC
8	NC

LAN RJ45 LED

The LAN_LED on top of RJ45 are to display the current network connection status. The green color LED on the right-hand side shows the link status and TX/RX activity.

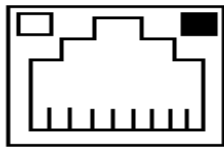

LNK/ACT	STATUS
GREEN	Link
OFF	Disconnected

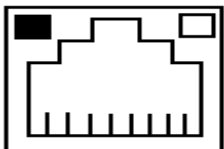

SPEED	MODE
Green	100 Mbps
OFF	10 Mbps

LVDS LCD Connector

The LCD panel, inverter for LCD LAMP, Touch-screen Serial Interface must be connected to this LVDS header, using the below described connector:

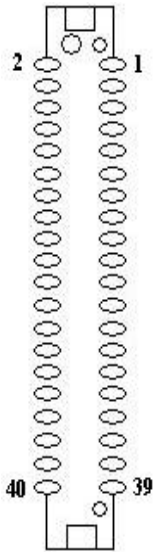

Signal Name	Pin #	Pin #	Signal Name
+12V	1	2	+12V
GND	3	4	GND
LCDVDD 5V/3.3V	5	6	LCDVDD 5V/3.3V
GND	7	8	GND
BRIGHTNES	9	10	BCKLITE_ON
LVDS_GND	11	12	LVDS_GND
CHA_TX0+	13	14	CHB_TX0+
CHA_TX0-	15	16	CHB_TX0-
LVDS_GND	17	18	LVDS_GND
CHA_TX1+	19	20	CHB_TX1+
CHA_TX1-	21	22	CHB_TX1-
LVDS_GND	23	24	LVDS_GND
CHA_TX2+	25	26	CHB_TX2+
CHA_TX2-	27	28	CHB_TX2-
LVDS_GND	29	30	LVDS_GND
CHA_TXC+	31	32	CHB_TXC+
CHA_TXC-	33	34	CHB_TXC-
LVDS_GND	35	36	LVDS_GND
CHA_TX3+	37	38	CHB_TX3+
CHA_TX3-	39	40	CHB_TX3-

CF-II Connector

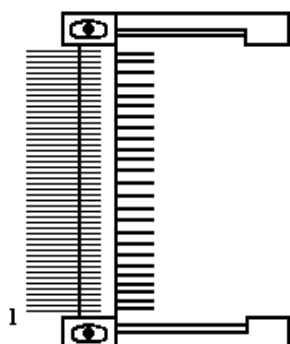

Signal Name	Pin #	Pin #	Signal Name
GND	1	2	PDD3
PDD4	3	4	PDD5
PDD6	5	6	PDD7
PCS1-	7	8	GND
GND	9	10	GND
GND	11	12	GND
VCC	13	14	GND
GND	15	16	GND
GND	17	18	PDA2
PDA1	19	20	PDA0
PDD0	21	22	PDD1
PDD2	23	24	N.C.
N.C.	25	26	N.C.
PDD11	27	28	PDD12
PDD13	29	30	PDD14
PDD15	31	32	PCS3-
N.C.	33	34	PDIOR-
PDIOW-	35	36	VCC
IRQ14	37	38	VCC
MST#_SLV	39	40	N.C.
PST1-	41	42	PIORDY
PDDREQ	43	44	PDDACK-
CF_LED-	45	46	N.C.
PDD8	47	48	PDD9
PDD10	49	50	GND

Chapter 3 BIOS Setup

This chapter describes the different settings available in the Award BIOS that comes with the ISA-E5 CPU card. The topics covered in this chapter are as follows:

BIOS Introduction.....	35
Main Menu.....	38
Standard CMOS Setup	40
Advanced BIOS Features	47
Advanced Chipset Features.....	53
Integrated Peripherals	58
Power Management Setup.....	63
PnP/PCI Configurations	69
PC Health Status	73
Frequency/Voltage Control	75
Load Fail-Safe Defaults	76
Load Optimized Defaults.....	76
Supervisor/User Password Setting.....	77
Exit Selecting	78

BIOS Introduction

This Chapter discusses Award™ Setup program built into the ISA-E5 BIOS. The Setup program allows users to modify the basic system configuration. This special information is then stored in battery-backed RAM so that it retains the Setup information when the power is turned off.

The AwardBIOS™ installed in ISA-E5 is a custom version of an industry standard BIOS. This means that it supports VIA C7/EDEN in a standard IBM-AT compatible input/output system. The BIOS provides critical low-level support for standard devices such as disk drives and serial and parallel ports.

It also adds non-standard, features such as virus and password protection as well as special support for detailed fine-tuning of the chipset controlling the entire system.

The rest of this chapter is intended to guide you through the process of configuring your system using Setup.

Starting Setup

The AwardBIOS™ is immediately activated when you first power on the computer. The BIOS reads the system information contained in the CMOS and begins the process of checking out the system and configuring it. When it finishes, the BIOS will seek an operating system on one of the disks and then launch and turn control over to the operating system.

While the BIOS is in control, the Setup program can be activated in one of two ways:

1. By pressing immediately after switching the system on, or
2. by pressing the key when the following message appears briefly at the bottom of the screen during the POST (Power On Self-Test).

Press DEL to enter SETUP.

If the message disappears before you respond and you still wish to enter Setup, restart the system to try again by turning it OFF then ON or pressing the "RESET" button on the system case. You may also restart by simultaneously pressing <Ctrl>, <Alt>, and <Delete> keys. If you

do not press the keys at the correct time and the system does not boot, an error message will be displayed and you will again be asked to...

PRESS F1 TO CONTINUE, DEL TO ENTER SETUP

Using Setup

In general, you use the arrow keys to highlight items, press <Enter> to select, use the PageUp and PageDown keys to change entries, press <F1> for help and press <Esc> to quit. The following table provides more detail about how to navigate in the Setup program using the keyboard.

Key	Function
Up Arrow	Move to the previous item
Down Arrow	Move to the next item
Left Arrow	Move to the item on the left (menu bar)
Right Arrow	Move to the item on the right (menu bar)
Esc	Main Menu: Quit without saving changes Submenus: Exit Current page to the next higher level menu
Move Enter	Move to the item you desired
PgUp key	Increase the numeric value or make changes
PgDn key	Decrease the numeric value or make changes
+ key	Increase the numeric value or make changes
- key	Decrease the numeric value or make changes
Esc key	Main Menu -- Quit and not save changes into CMOS Status Page Setup Menu and Option Page Setup Menu -- Exit current page and return to Main Menu
F1 key	General help on Setup navigation keys
F5 key	Load previous values from CMOS
F6 key	Load the fail-safe defaults from BIOS default table
F7 key	Load the optimized defaults
F10 key	Save all the CMOS changes and exit

Navigating through the menu bar

Use the left and right arrow keys to choose the menu you want to be in.

To display a sub menu

Use the arrow keys to move the cursor to the sub menu you want. Then press <Enter>. A “>” pointer marks all sub menus.

Getting Help

Press F1 to pop up a small help window that describes the appropriate keys to use and the possible selections for the highlighted item. To exit the Help Window press <Esc> or the F1 key again.

In Case of Problems

If, after making and saving system changes with Setup, you discover that your computer no longer is able to boot, the AwardBIOS™ supports an override to the CMOS settings which resets your system to its defaults.

The best advice is to only alter settings that you thoroughly understand. To this end, we strongly recommend that you avoid making any changes to the chipset defaults. These defaults have been carefully chosen by both Award and ISA-E5 manufacturer to provide the absolute maximum performance and reliability. Even a seemingly small change to the chipset setup has the potential for causing you to use the override.

Main Menu

Once you enter the AwardBIOS™ CMOS Setup Utility, the Main Menu will appear on the screen. The Main Menu allows you to select from several setup functions and two exit choices. Use the arrow keys to select among the items and press <Enter> to accept and enter the sub-menu.

Phoenix – AwardBIOS CMOS Setup Utility

➤ Standard CMOS Features	➤ Frequency/Voltage Control
➤ Advanced BIOS Features	Load Fail-Safe Defaults
➤ Advanced Chipset Features	Load Optimized Defaults
➤ Integrated Peripherals	Set Supervisor Password
➤ Power Management Setup	Set User Password
➤ PnP/PCI Configurations	Save & Exit Setup
➤ PC Health Status	Exit Without Saving
Esc : Quit	↑ ↓ → ← : Select Item
F10 : Save & Exit Setup	
Time, Date, Hard Disk Type...	

Note that a brief description of each highlighted selection appears at the bottom of the screen.

Setup Items

The main menu includes the following main setup categories.

Standard CMOS Features

Use this menu for basic system configuration.

Advanced BIOS Features

Use this menu to set the Advanced Features available on your system.

Advanced Chipset Features

Use this menu to change the values in the chipset registers and optimize your system's performance.

Integrated Peripherals

Use this menu to specify your settings for integrated peripherals.

Power Management Setup

Use this menu to specify your settings for power management.

PnP / PCI Configurations

Use this menu to set up the PnP/PCI configuration.

PC Health Status

Use this menu to display the CPU temperature, FAN speed and voltages.

Frequency/Voltage Control

Use this menu to specify your settings for frequency/voltage control.

Load Fail-Safe Defaults

Use this menu to load the BIOS default values for the minimal/stable performance for your system to operate.

Load Optimized Defaults

Use this menu to load the BIOS default values that are factory settings for optimal performance system operations. While Award has designed the custom BIOS to maximize performance, the factory has the right to change these defaults to meet their needs.

Supervisor / User Password

Use this menu to set User and Supervisor Passwords.

Save & Exit Setup

Save CMOS value changes to CMOS and exit setup.

Exit Without Save

Abandon all CMOS value changes and exit setup.

Standard CMOS Setup

The items in Standard CMOS Setup Menu are divided into 10 categories. Each category includes no, one or more than one setup items. Use the arrow keys to highlight the item and then use the <PgUp> or <PgDn> keys to select the value you want in each item.

Phoenix – AwardBIOS CMOS Setup Utility		Item Help
Standard CMOS Features		
Date(mm:dd:yy):	Wed, Oct 25 2006	
Time(hh:mm:ss)	14 : 23 : 51	
➤ IDE Channel 0 Master	[None]	Menu Level ➤
➤ IDE Channel 0 Slave	[None]	Change the day, month, year and century
➤ IDE Channel 1 Master	[None]	
➤ IDE Channel 1 Slave	[None]	
➤ IDE Channel 2 Master	[None]	
➤ IDE Channel 3 Master	[None]	
Drive A	[1.44M, 3.5 in.]	
Drive B	[None]	
Video	[EGA/VGA]	
Halt On	[No Errors]	
Base Memory	640K	
Extended Memory	194560K	
Total Memory	195584K	
↑↓→←: Move Enter: Select +/-/PU/PD: Value F10:Save ESC: Exit F1:General Help F5: Previous Values F6: Fail-safe Defaults F7: Optimized Defaults		

This table shows the selections that you can make on the Standard CMOS Menu

Item	Options	Description
Date	Month DD YYYY	Set the system date. Note that the 'Day' automatically changes when you set the date
Time	HH: MM : SS	Set the system time
IDE Channel 0 Master	Options are in its sub menu	Press <Enter> to enter the sub menu of detailed options
IDE Channel 0 Slave	Options are in its sub menu	Press <Enter> to enter the sub menu of detailed options
IDE Channel 1 Master	Options are in its sub menu	Press <Enter> to enter the sub menu of detailed options
IDE Channel 1 Slave	Options are in its sub menu	Press <Enter> to enter the sub menu of detailed options
IDE Channel 2 Master	Options are in its sub menu	Press <Enter> to enter the sub menu of detailed options
IDE Channel 3 Master	Options are in its sub menu	Press <Enter> to enter the sub menu of detailed options
Drive A Drive B	None 360K, 5.25 in 1.2M, 5.25 in 720K, 3.5 in 1.44M, 3.5 in 2.88M, 3.5 in	Select the type of floppy disk drive installed in your system
Video	EGA/VGA CGA 40 CGA 80 MONO	Select the default video device
Halt On	All Errors No Errors All, But Keyboard All, But Diskette All, But Disk/Key	Select the situation in which you want the BIOS to stop the POST process and notify you
Base Memory	N/A	Displays the amount of conventional memory detected during boot up
Extended Memory	N/A	Displays the amount of extended memory detected during boot up
Total Memory	N/A	Displays the total memory available in the system

Channel 0 HDDs / Channel 1 HDDs

The IDE adapters control the hard disk drive. Use a separate sub menu to configure each hard disk drive. Figure 2 shows the IDE Channel 0/ Channel 1master and slave sub menu.

Phoenix – AwardBIOS CMOS Setup Utility		
IDE Channel 0 Master		
IDE HDD Auto-Detection	[Press Enter]	Item Help
IDE Channel 0 Master	[Auto]	
Access Mode	[Auto]	Menu Level >>
Capacity	0 MB	To auto-detect the HDD's size, head... on this channel
Cylinder	0	
Head	0	
Precomp	0	
Landing Zone	0	
Sector	0	
↑↓→←: Move Enter: Select +/-/PU/PD: Value F10: Save ESC: Exit F1:General Help F5: Previous Values F6: Fail-safe Defaults F7: Optimized Defaults		

Use the legend keys to navigate through this menu and exit to the main menu. Use the Table listed below to configure the hard disk.

Item	Options	Description
IDE HDD Auto-detection	Press Enter	Press Enter to auto-detect the HDD on this channel. If detection is successful, it fills the remaining fields on this menu.
IDE Channel 0 Master	None Auto Manual	Selecting 'manual' lets you set the remaining fields on this screen. Selects the type of fixed disk. "User Type" will let you select the number of cylinders, heads, etc. Note: PRECOMP=65535 means NONE!
Capacity	Auto Display your disk drive size	Disk drive capacity (Approximated). Note that this size is usually slightly greater than the size of a formatted disk given by a disk checking program.
Access Mode	CHS LBA Large Auto	Choose the access mode for this hard disk
The following options are selectable only if the 'IDE Channel 0 Master' item is set to 'Manual'		
Cylinder	Min = 0 Max = 65535	Set the number of cylinders for this hard disk.
Head	Min = 0 Max = 255	Set the number of read/write heads
Precomp	Min = 0 Max = 65535	**** Warning: Setting a value of 65535 means no hard disk
Landing zone	Min = 0 Max = 65535	****
Sector	Min = 0 Max = 255	Number of sectors per track

Channel 2 HDDs / Channel 3 HDDs

The IDE adapters control the hard disk drive. Use a separate sub menu to configure each hard disk drive. Figure 2 shows the IDE Channel 2/ Channel 3 master sub menu.

Phoenix – AwardBIOS CMOS Setup Utility		
IDE Channel 2 Master		
IDE Auto-Detection	[Press Enter]	Item Help
Extended IDE Drive	[Auto]	Menu Level >>
Access Mode	[Auto]	
Capacity	0 MB	To auto-detect the HDD's size, head... on this channel
Cylinder	0	
Head	0	
Precomp	0	
Landing Zone	0	
Sector	0	
↑↓→←: Move Enter: Select +/-/PU/PD: Value F10: Save ESC: Exit F1: General Help F5: Previous Values F6: Fail-safe Defaults F7: Optimized Defaults		

Use the legend keys to navigate through this menu and exit to the main menu. Use the Table listed below to configure the hard disk.

Item	Options	Description
IDE Auto-detection	Press Enter	Press Enter to auto-detect the HDD on this channel. If detection is successful, it fills the remaining fields on this menu.
Extended IDE Drive	None Auto	Selects the type of fixed disk. "User Type" will let you select the number of cylinders, heads, etc. Note: PRECOMP=65535 means NONE!
Capacity	Auto Display your disk drive size	Disk drive capacity (Approximated). Note that this size is usually slightly greater than the size of a formatted disk given by a disk checking program.
Access Mode	Large Auto	Choose the access mode for this hard disk

Drive A / Drive B

These fields identify the types of floppy disk drive A or drive B that has been installed in the computer. The available specifications are:

None	360KB	1.2MB	720KB	1.44MB	2.88MB
	5.25 in.	5.25 in.	3.5 in.	3.5 in.	3.5 in.

Video

This field selects the type of video display card installed in your system. You can choose the following video display cards:

EGA/VGA	For EGA, VGA, SEGA, SVGA or PGA monitor adapters. (default)
CGA 40	Power up in 40 column mode.
CGA 80	Power up in 80 column mode.
MONO	For Hercules or MDA adapters.

Halt On

This field determines whether the system will halt if an error is detected during power up.

All Errors	Whenever the BIOS detects a non-fatal error, the system will stop and you will be prompted.
No Errors	The system boot will not be halted for any error that may be detected. (default)
All, But Keyboard	The system boot will not be halted for a keyboard error; it will stop for all other errors
All, But Diskette	The system boot will not be halted for a disk error; it will stop for all other errors.
All, But Disk/Key	The system boot will not be halted for a keyboard or disk error; it will stop for all others.

Advanced BIOS Features

This section allows you to configure your system for basic operation. You have the opportunity to select the system's default speed, boot-up sequence, keyboard operation, shadowing and security.

Phoenix – AwardBIOS CMOS Setup Utility		
Advanced BIOS Features		
➤ CPU Feature	[Press Enter]	Item Help
➤ Hard Disk Boot Priority	[Press Enter]	
Virus Warning	[Disabled]	Menu Level ➤
CPU L1 & L2 Cache	[Enabled]	
CPU L2 Cache ECC Checking	[Enabled]	
Quick Power On Self Test	[Enabled]	
First Boot Device	[Floppy]	
Second Boot Device	[Hard Disk]	
Third Boot Device	[CDROM]	
Boot Other Device	[Enabled]	
Swap Floppy Drive	[Disabled]	
Boot Up Floppy Seek	[Enabled]	
Boot Up NumLock Status	[Off]	
Typematic Rate Setting	[Disabled]	
x Typematic Rate (Chars/Sec)	6	
x Typematic Delay (Msec)	250	
Security Option	[Setup]	
MPS Version Control For OS	[1.4]	
OS Select For DRAM > 64MB	[Non-OS2]	
Video BIOS Shadow	[Enabled]	
Small Logo(EPA) Show	[Disabled]	
↑↓→←: Move Enter: Select +/-/PU/PD: Value F10: Save ESC: Exit F1: General Help F5: Previous Values F6: Fail-safe Defaults F7: Optimized Defaults		

CPU Feature

Phoenix – AwardBIOS CMOS Setup Utility		
CPU Feature		
Delay Prior to Thermal	[16 Min]	Item Help
Thermal Management	[Thermal Monitor 1]	
X TM2 Bus Ratio	10 X	Menu Level >
X TM2 Bus VID	0.844V	

↑↓→←: Move Enter: Select +/-/PU/PD: Value F10: Save ESC: Exit F1: General Help
F5: Previous Values F6: Fail-safe Defaults F7: Optimized Defaults

Delay Prior to Thermal

Delay Prior To Thermal is set at 16 minutes as default, which means the board will wait 16 minutes before it activates the processor's integrated thermal control circuit.

The choice: 4 Min , 8 Min, 16 Min, 32 Min.

Thermal Management

The CPU Thermal Management is as TM1 as default.

Thermal Monitor 1: When CPU over-heated, the CPU internal clock begin on die frequency throttling.

Thermal Monitor 2: When CPU over-heated, the CPU output VID will adjust Vcore to designated voltage. In the meantime, the core frequency speed will also slow down to (FSB MHz X Bus Ratio) MHz.

The choice: Thermal Monitor 1, Thermal Monitor 2.

TM2 Bus Ratio

The choice: Min = 4
Max = 10

Key in a DEC number :

TM2 Bus VID

The choice: 0.700V, 0.716V, 0.732V, 0.748V, 0.764V, 0.780V, 0.796V, 0.812V, 0.828V, 0.844V.

Hard Disk Boot Priority

Phoenix – AwardBIOS CMOS Setup Utility Hard Disk Boot Priority	
1. Bootable ADD-in Cards	Item Help Menu Level ➤ Use <↑> or <↓> to select a device, then press <+> to move it up, or <-> to move it down the list. Press <ESC> to exit this menu.
↑↓: Move PU/PD/+/-: Change Priority F10: Save ESC: Exit F5: Previous Values F6: Fail-safe Defaults F7: Optimized Defaults	

Bootable ADD-in Cards

Use <↑> or <↓> to select a device, then press <+> to move it up, or <-> to move it down the list. Press <ESC> to exit this menu.

Virus Warning

Allows you to choose the VIRUS Warning feature for IDE Hard Disk boot sector protection. If this function is enabled and someone attempt to write data into this area, BIOS will show a warning message on screen and alarm beep.

Enabled	Activates automatically when the system boots up causing a warning message to appear when anything attempts to access the boot sector or hard disk partition table.
Disabled	No warning message will appear when anything attempts to access the boot sector or hard disk partition table.

CPU L1 & L2 Cache

These two categories speed up memory access. However, it depends on CPU/chipset design.

Enabled	Enable cache
Disabled	Disable cache

CPU L2 Cache ECC Checking

The choice: Enabled, Disabled.

Quick Power On Self Test

Allows the system to skip certain tests while booting. This will decrease the time needed to boot the system.

Enabled	Enable quick POST
Disabled	Normal POST

First/Second/Third/Other Boot Device

The BIOS attempts to load the operating system from the devices in the sequence selected in these items.

The Choice: Floppy, LS120, Hard-Disk, ZIP100, CDROM, Disabled, Enabled, USB-FDD, USB-ZIP, USB-CDROM, Legacy LAN.

Swap Floppy Drive

If the system has two floppy drives, choose enable to assign physical drive B to logical drive A and vice-versa.

The choice: Enabled, Disabled.

Boot Up Floppy Seek

Enabled tests floppy drives to determine whether they have 40 or 80 tracks.

The choice: Enabled, Disabled.

Boot Up NumLock Status

Selects power on state for NumLock.

The choice: On, Off.

Typematic Rate Setting

Keystrokes repeat at a rate determined by the keyboard controller. When enabled, the typematic rate and typematic delay can be selected.

The choice: Enabled, Disabled.

Typematic Rate (Chars/Sec)

Sets the number of times a second to repeat a keystroke when you hold the key down.

The choice: 6, 8, 10, 12, 15, 20, 24, 30.

Typematic Delay (Msec)

Sets the delay time after the key is held down before it begins to repeat the keystroke.

The choice: 250, 500, 750, 1000.

Security Option

Select whether the password is required every time the system boots or only when you enter setup.

System	The system will not boot and access to Setup will be denied if the correct password is not entered at the prompt.
Setup	The system will boot, but access to Setup will be denied if the correct password is not entered at the prompt.

Note: To disable security, select PASSWORD SETTING at Main Menu and then you will be asked to enter password. Do not type anything and just press <Enter>, it will disable security. Once the security is disabled, the system will boot and you can enter Setup freely.

MPS Version Control For OS

The choice: 1.1, 1.4.

OS Select For DRAM > 64MB

Select OS2 only if you are running OS/2 operating system with greater than 64MB of RAM on the system.

The choice: Non-OS2, OS2.

Video BIOS Shadow

Enabled copies Video BIOS to shadow RAM Improves performance.

The choice: Enabled, Disabled.

Small Logo (EPA) Show

The choice: Enabled, Disabled.

Advanced Chipset Features

Phoenix – AwardBIOS CMOS Setup Utility		
Advanced Chipset Features		
➤ DRAM Clock/Drive Control	[Press Enter]	Item Help
➤ AGP & P2P Bridge Control	[Press Enter]	
➤ CPU & PCI Bus Control	[Press Enter]	Menu Level ➤
Memory Hole	[Disabled]	
System BIOS Cacheable	[Enabled]	
Video RAM Cacheable	[Disabled]	
Init Display First	[PCI Slot]	
↑↓→←: Move Enter: Select +/-/PU/PD: Value F10: Save ESC: Exit F1: General Help F5: Previous Values F6: Fail-safe Defaults F7: Optimized Defaults		

This section allows you to configure the system based on the specific features of the installed chipset. This chipset manages bus speeds and access to system memory resources, such as DRAM and the external cache. It also coordinates communications between the conventional ISA bus and the PCI bus. It must be stated that these items should never need to be altered. The default settings have been chosen because they provide the best operating conditions for your system. The only time you might consider making any changes would be if you discovered that data was being lost while using your system.

DRAM Settings

The first chipset settings deal with CPU access to dynamic random access memory (DRAM). The default timings have been carefully chosen and should only be altered if data is being lost. Such a scenario might well occur if your system had mixed speed DRAM chips installed so that greater delays may be required to preserve the integrity of the data held in the slower memory chips.

DRAM Clock/Drive Control

Phoenix – AwardBIOS CMOS Setup Utility		
DRAM Clock/Drive Control		
Current FSB Frequency	100MHz	Item Help
Current DRAM Frequency	200MHz	
DRAM Clock	[By SPD]	Menu Level ➤
DRAM Timing	[Auto By SPD]	
X SDRAM CAS Latency [DDR/DDR	2.5/ 4	
X Bank Interleave	Disabled	
X Precharge to Active (Trp)	2T	
X Active to Precharge (Tras)	05T	
X Active to CMD (Tred)	4T	
X REF to ACT/REF (Trfc)	21T	
X ACT (0) to ACT (1) (TRRD)	3T	

↑↓→←: Move Enter: Select +/-/PU/PD: Value F10: Save ESC: Exit F1:General Help
F5: Previous Values F6: Fail-safe Defaults F7: Optimized Defaults

Current FSB Frequency

The choice: 100MHz.

Current DRAM Frequency

The choice: 200MHz.

DRAM Clock

The choice: By SPD, 100MHz, 133MHz, 166MHz, 200MHz.

DRAM Timing

The choice: Manual, Auto By SPD.

SDRAM CAS Latency [DDR/DDR2]

The choice: 1.5/ 2, 2/ 3, 2.5/ 4, 3/ 5.

Bank Interleave

The choice: Disabled, 2 Bank, 4 Bank, 8 Bank.

Precharge to Active(Trp)

The choice: 2T, 3T, 4T, 5T.

Active to Precharge(Tras)

The choice: 05T, 06T, 07T, 08T, 09T, 10T, 11T, 12T, 13T, 14T, 15T, 16T, 17T, 18T, 19T, 20T.

Active to CMD(Trcd)

The choice: 2T, 3T, 4T, 5T.

REF to ACT/REF (Trfc)

The choice: 08T, 09T, 10T, 11T, 12T, 13T, 14T, 15T, 16T, 17T, 18T, 19T, 20T, 21T, 22T, 23T, 24T, 25T, 26T, 27T, 28T, 29T, 30T, 31T, 32T, 33T, 34T, 35T, 36T, 37T, 38T, 39T, 40T, 41T, 42T, 43T, 44T, 45T, 46T, 47T, 48T, 49T, 50T, 51T, 52T, 53T, 54T, 55T, 56T, 57T, 58T, 59T, 60T, 61T, 62T, 63T, 64T, 65T, 66T, 67T, 68T, 69T, 70T, 71T.

ACT(0) to ACT(1) (TRRD)

The choice: 2T, 3T, 4T, 5T.

AGP & P2P Bridge Control

Phoenix – AwardBIOS CMOS Setup Utility		
AGP & P2P Bridge Control		
AGP Aperture Size	[128M]	Item Help
VGA Share Memory Size	[64M]	
Direct Frame Buffer	[Enabled]	Menu Level ➤
Select Display Device	[CRT+LCD]	
Panel Type	[02]	

↑↓→←: Move Enter: Select +/-/PU/PD: Value F10: Save ESC: Exit F1:General Help
F5: Previous Values F6: Fail-safe Defaults F7: Optimized Defaults

AGP Aperture Size

The choice: 32M, 64M, 128M, 256M, 512M, 1G.

VGA Share Memory Size

The choice: Disabled, 16M, 32M, 64M.

Direct Frame Buffer

The choice: Enabled, Disabled.

Select Display Device

The choice: CRT, LCD, TV, DVI, HDTV, CRT+LCD, CRT+TV, CRT+DVI, CRT+HDTV, DVI+HDTV, LCD+DVI, TV+DVI.

Panel Type

The choice: Min=0000
Max=000F

Key in a HEX number:

CPU & PCI Bus Control

Phoenix – AwardBIOS CMOS Setup Utility		
CPU & PCI Bus Control		
PCI Master 0 WS Write	[Enabled]	Item Help
PCI Delay Transaction	[Enabled]	
		Menu Level >
↑↓→←: Move Enter: Select +/-/PU/PD: Value F10: Save ESC: Exit F1: General Help F5: Previous Values F6: Fail-safe Defaults F7: Optimized Defaults		

PCI Master 0 WS Write

The choice: Enabled, Disabled.

PCI Delay Transaction

The choice: Enabled, Disabled.

Memory Hole

In order to improve performance, certain space in memory can be reserved for ISA cards. This field allows you to reserve 15MB to 16MB memory address space to ISA expansion cards. This makes memory from 15MB and up unavailable to the system. Expansion cards can only access memory up to 16MB. The default of this field is set to *Disabled*.

The choice: Disabled, 15M-16M.

System BIOS Cacheable

Selecting *Enabled* allows caching of the system BIOS ROM at F0000h-FFFFFh, resulting in better system performance. However, if any program writes to this memory area, a system error may result.

The choice: Enabled, Disabled.

Video RAM Cacheable

The choice: Enabled, Disabled.

Init Display First

The choice: PCI Slot, AGP.

Integrated Peripherals

Phoenix – AwardBIOS CMOS Setup Utility		
Integrated Peripherals		
➤ VIA OnChip IDE Device	[Press Enter]	Item Help
➤ VIA OnChip PCI Device	[Press Enter]	
➤ SuperIO Device	[Press Enter]	
PWRON After PWR-Fail	[Off]	Menu Level ➤
Onboard Serial Port 3	[3E8]	
Serial Port 3 Use IRQ	[IRQ4]	
Onboard Serial Port 4	[2E8]	
Serial Port 4 Use IRQ	[IRQ3]	
Onboard Serial Port 5	[3E0]	
Serial Port 5 Use IRQ	[IRQ5]	
Onboard Serial Port 6	[2E0]	
Serial Port 6 Use IRQ	[IRQ7]	
Watch Dog Timer Select	[Disabled]	
↑↓→←: Move Enter: Select +/-/PU/PD: Value F10: Save ESC: Exit F1: General Help F5: Previous Values F6: Fail-safe Defaults F7: Optimized Defaults		

VIA OnChip IDE Device

Phoenix – AwardBIOS CMOS Setup Utility		
VIA OnChip IDE Device		
OnChip SATA	[Enabled]	Item Help
SATA Mode	[IDE]	
IDE DMA transfer access	[Enabled]	
OnChip IDE Channel0	[Enabled]	Menu Level ➤
OnChip IDE Channel1	[Enabled]	
IDE Prefetch Mode	[Enabled]	
Primary Master PIO	[Auto]	
Primary Slave PIO	[Auto]	
Secondary Master PIO	[Auto]	
Secondary Slave PIO	[Auto]	
Primary Master UDMA	[Auto]	
Primary Slave UDMA	[Auto]	
Secondary Master UDMA	[Auto]	
Secondary Slave UDMA	[Auto]	
IDE HDD Block Mode	[Enabled]	
↑↓→←: Move Enter: Select +/-/PU/PD: Value F10: Save ESC: Exit F1: General Help F5: Previous Values F6: Fail-safe Defaults F7: Optimized Defaults		

OnChip SATA

The choice: Enabled, Disabled.

SATA Mode

The choice: IDE, RAID.

IDE DMA transfer access

The choice: Enabled, Disabled.

OnChip IDE Channel0

The choice: Enabled, Disabled.

OnChip IDE Channel1

The choice: Enabled, Disabled.

IDE Prefetch Mode

The choice: Enabled, Disabled.

Primary/Secondary Master/Slave PIO

The choice: Auto, Mode 0, Mode 1, Mode 2, Mode 3, Mode 4.

Primary/Secondary Master/Slave UDMA

The choice: Auto, Disabled.

IDE HDD Block Mode

If your IDE hard drive supports block mode select Enabled for automatic detection of the optimal number of block read/writes per sector the drive can support.

The choice: Enabled, Disabled.

VIA OnChip PCI Device

Phoenix – AwardBIOS CMOS Setup Utility		
VIA OnChip PCI Device		
AC97 Audio	[Auto]	Item Help
VIA VT6103 LAN	[Enabled]	
OnChip USB Controller	[All Enabled]	
OnChip EHCI Controller	[Enabled]	Menu Level >
USB Emulation	[ON]	
X USB Keyboard Support	Enabled	
X USB Mouse Support	Enabled	

↑↓→←: Move Enter: Select +/-/PU/PD: Value F10: Save ESC: Exit F1: General Help
F5: Previous Values F6: Fail-safe Defaults F7: Optimized Defaults

AC97 Audio

The choice: Auto, Disabled.

VIA VT6103 LAN

The choice: Enabled, Disabled.

OnChip USB Controller

The choice: All Disabled, All Enabled, 1&2 USB Port, 2&3 USB Port, 1&3 USB Port, 1 USB Port, 2 USB Port, 3 USB Port.

OnChip EHCI Controller

The choice: Enabled, Disabled.

USB Emulation

- OFF Don't support any USB device on DOS.
- KB/MS Support USB legacy Keyboard and Mouse, No Support USB Storage.
- ON Support USB legacy Keyboard, Mouse and Storage.

The choice: OFF, KB/MS, ON.

USB Keyboard Support

Select *Enabled* if your system contains a Universal Serial Bus (USB) controller and you have a USB keyboard.

The choice: Enabled, Disabled.

USB Mouse Support

The choice: Enabled, Disabled.

SuperIO Device

Phoenix – AwardBIOS CMOS Setup Utility		
SuperIO Device		
Onboard FDC Controller	[Enabled]	Item Help
Onboard Serial Port 1	[3F8/IRQ4]	
Onboard Serial Port 2	[2F8/IRQ3]	
UART Mode Select	[Normal]	Menu Level >
X RxD , TxD Active	Hi , Lo	
X IR Transmission Delay	Enabled	
X UR2 Duplex Mode	Half	
Onboard Parallel Port	[378/IRQ7]	
Parallel Port Mode	[SPP]	
X EPP Mode Select	EPP1,7	
X ECP Mode Use DMA	3	

↑↓→←: Move Enter: Select +/-/PU/PD: Value F10: Save ESC: Exit F1: General Help
F5: Previous Values F6: Fail-safe Defaults F7: Optimized Defaults

Onboard FDC Controller

The choice: Enabled, Disabled.

Onboard Serial Port 1/Port 2

Select an address and corresponding interrupt for the first and second serial ports.

The choice: 3F8/IRQ4, 2F8/IRQ3, 3E8/IRQ4, 2E8/IRQ3, Disabled, Auto.

UART Mode Select

The choice: IrDA, ASKIR, Normal.

RxD, TxD Active

The choice: Hi, Hi Hi, Lo Lo, Hi Lo, Lo.

IR Transmission Delay

The choice: Enabled, Disabled.

UR2 Duplex Mode

The choice: Full, Half.

Onboard Parallel Port

This item allows you to determine onboard parallel port controller I/O address setting.

The choice: 378/IRQ7, 278/IRQ5, 3BC/IRQ7, Disabled.

Parallel Port Mode

Select an operating mode for the onboard parallel (printer) port. Select *Normal*, *Compatible*, or *SPP* unless you are certain your hardware and software both support one of the other available modes.

The choice: SPP, EPP, ECP, ECP+EPP, Normal.

EPP Mode Select

Select EPP port type 1.7 or 1.9.

The choice: EPP1.7, EPP 1.9.

ECP Mode Use DMA

Select a DMA channel for the parallel port for use during ECP mode.

The choice: 3, 1.

PWRON After PWR-Fail

The choice: Off, On, Former-Sts.

Onboard Serial Port 3/Port 4/Port 5/Port 6

The choice: 3E0, 2E0, 3E8, 2E8, Disabled.

Serial Port 3/Port 4/Port 5/Port 6 Use IRQ

The choice: IRQ3, IRQ4, IRQ5, IRQ7, IRQ10, IRQ11.

Watch Dog Timer Select

The choice: Enable, Disabled.

Power Management Setup

The Power Management Setup allows you to configure your system to most effectively save energy while operating in a manner consistent with your own style of computer use.

Phoenix – AwardBIOS CMOS Setup Utility		
Power Management Setup		
ACPI function	[Enabled]	Item Help
Power Management Option	[User Define]	
HDD Power Down	[Disable]	Menu Level ➤
Suspend Mode	[Disable]	
Video off Option	[Suspend - > Off]	
Video off Method	[V/H SYNC+Blank]	
MODEM Use IRQ	[3]	
Soft-Off by PWRBTN	[Instant-Off]	
➤IRQ/Event Activity Detect	[Press Enter]	

↑↓→←: Move Enter: Select +/-/PU/PD: Value F10: Save ESC: Exit F1: General Help
F5: Previous Values F6: Fail-safe Defaults F7: Optimized Defaults

ACPI Function

This item allows you to enable/disable the Advanced Configuration and Power Management (ACPI).

The choice: Enabled, Disabled.

Power Management Option

This category allows you to select the type (or degree) of power saving and is directly related to the following modes:

1. HDD Power Down
2. Suspend Mode

There are three selections for Power Management, three of which have fixed mode settings.

Min. Power Saving	Minimum power management. Suspend Mode = 1 hr., and HDD Power Down = 15 min.
Max. Power Saving	Maximum power management. Suspend Mode = 1 min., and HDD Power Down = 1 min.
User Define	Allows you to set each mode individually. The Suspend mode ranges are from 1 min. to 1 hr. The HDD Power Down ranges are from 1 min. to 15 min. and disable.

HDD Power Down

The choice: Disable, 1 Min, 2 Min, 3 Min, 4 Min, 5 Min, 6 Min, 7 Min, 8 Min, 9 Min, 10 Min, 11 Min, 12 Min, 13 Min, 14 Min, 15 Min.

Suspend Mode

The choice: 1Min, 2Min, 4Min, 6 Min, 8Min, 10Min, 20Min, 30Min, 40Min, 1Hour, Disable.

Video Off Option

The choice: Always On, Suspend - > Off.

Video Off Method

This determines the manner in which the monitor is blanked.

V/H SYNC+Blank	This selection will cause the system to turn off the vertical and horizontal synchronization ports and write blanks to the video buffer.
Blank Screen	This option only writes blanks to the video buffer.
DPMS Support	Initial display power management signaling. Allows the BIOS to control video display card if it supports the DPMS feature.

MODEM Use IRQ

The choice: NA, 3, 4, 5, 7, 9, 10, 11.

Soft-Off by PWRBTN

The choice: Instant-Off, Delay 4 Sec.

IRQ/Event Activity Detect

Phoenix – AwardBIOS CMOS Setup Utility		
IRQ/Event Activity Detect		
PS2KB Wakeup from S3/S4/S5	[Disable]	Item Help
PS2MS Wakeup from S3/S4/S5	[Disabled]	
USB Resume from S3	[Disabled]	
VGA	[OFF]	Menu Level ➤
LPT & COM	[LPT/COM]	
HDD & FDD	[ON]	
PCI Master	[OFF]	
PowerOn by PCI Card	[Disabled]	
Modem Ring Resume	[Disabled]	
RTC Alarm Resume	[Disabled]	
X Date (of Month)	0	
X Resume Time (hh : mm : ss)	0 : 0 : 0	
➤IRQs Activity Monitoring	[Press Enter]	
↑↓→←: Move Enter: Select +/-/PU/PD: Value F10: Save ESC: Exit F1: General Help F5: Previous Values F6: Fail-safe Defaults F7: Optimized Defaults		

PS2KB Wakeup from S3/S4/S5

The choice: Disable, Ctrl+F1, Ctrl+F2, Ctrl+F3, Ctrl+F4, Ctrl+F5, Ctrl+F6, Ctrl+F7, Ctrl+F8, Ctrl+F9, Ctrl+F10, Ctrl+F11, Ctrl+F12, Power, Wake, Any Key.

PS2MS Wakeup from S3/S4/S5

The choice: Enabled, Disabled.

USB Resume from S3

The choice: Enabled, Disabled.

VGA

The choice: OFF, ON.

LPT & COM

The choice: NONE, LPT, COM, LPT/COM.

HDD & FDD

The choice: OFF, ON.

PCI Master

The choice: OFF, ON.

PowerOn by PCI Card

The choice: Enabled, Disabled.

Modem Ring Resume

The choice: Enabled, Disabled.

RTC Alarm Resume

The choice: Enabled, Disabled.

Date (of Month)

The choice: Min= 0
 Max= 31

Key in a DEC number:

Resume Time (hh:mm:ss)

The choice: Min= 0
Max= 23

Key in a DEC number:

IRQs Activity Monitoring

Phoenix – AwardBIOS CMOS Setup Utility		
IRQs Activity Monitoring		
Primary INTR	[ON]	Item Help
IRQ3 (COM 2)	[Disabled]	
IRQ4 (COM 1)	[Enabled]	
IRQ5 (LPT 2)	[Enabled]	
IRQ6 (Floppy Disk)	[Enabled]	Menu Level ➤
IRQ7 (LPT 1)	[Enabled]	
IRQ8 (RTC Alarm)	[Disabled]	
IRQ9 (IRQ2 Redir)	[Disabled]	
IRQ10 (Reserved)	[Disabled]	
IRQ11 (Reserved)	[Disabled]	
IRQ12 (PS/2 Mouse)	[Enabled]	
IRQ13 (Coprocessor)	[Enabled]	
IRQ14 (Hard Disk)	[Enabled]	
IRQ15 (Reserved)	[Disabled]	

↑↓→←: Move Enter: Select +/-/PU/PD: Value F10: Save ESC: Exit F1: General Help
F5: Previous Values F6: Fail-safe Defaults F7: Optimized Defaults

Primary INTR

The choice: OFF, ON.

IRQ3 (COM 2)

The choice: Enabled, Disabled.

IRQ4 (COM 1)

The choice: Enabled, Disabled.

IRQ5 (LPT 2)

The choice: Enabled, Disabled.

IRQ6 (Floppy Disk)

The choice: Enabled, Disabled.

IRQ7 (LPT 1)

The choice: Enabled, Disabled.

IRQ8 (RTC Alarm)

The choice: Enabled, Disabled.

IRQ9 (IRQ2 Redir)

The choice: Enabled, Disabled.

IRQ10 (Reserved)

The choice: Enabled, Disabled.

IRQ11 (Reserved)

The choice: Enabled, Disabled.

IRQ12 (PS/2 Mouse)

The choice: Enabled, Disabled.

IRQ13 (Coprocessor)

The choice: Enabled, Disabled.

IRQ14 (Hard Disk)

The choice: Enabled, Disabled.

IRQ15 (Reserved)

The choice: Enabled, Disabled.

PnP/PCI Configuration Setup

This section describes configuring the PCI bus system. PCI, or **Personal Computer Interconnect**, is a system which allows I/O devices to operate at speeds nearing the speed the CPU itself uses when communicating with its own special components. This section covers some very technical items and it is strongly recommended that only experienced users should make any changes to the default settings.

Phoenix – AwardBIOS CMOS Setup Utility		
PnP/PCI Configurations		
PNP OS Installed	[No]	Item Help
Reset Configuration Data	[Disabled]	
Resources Controlled By	[Auto(ESCD)]	Menu Level ➤
X IRQ Resources	Press Enter	Select Yes if you are using a Plug and Play capable operating system Select No if you need the BIOS to configure non-boot devices
X DMA Resources	Press Enter	
PCI/VGA Palette Snoop	[Disabled]	
Assign IRQ For VGA	[Enabled]	
Assign IRQ For USB	[Enabled]	
↑↓→←: Move Enter: Select +/-/PU/PD: Value F10: Save ESC: Exit F1: General Help F5: Previous Values F6: Fail-safe Defaults F7: Optimized Defaults		

PNP OS Installed

Select Yes if you are using a Plug and Play capable operating system. Select No if you need the BIOS to configure non-boot devices.

The choice: No, Yes.

Reset Configuration Data

Default is Disabled. Select Enabled to reset Extended System Configuration Data (ESCD) when you exit Setup if you have installed a new add-on and the system reconfiguration has caused such a serious conflict that the OS cannot boot.

The choice: Enabled, Disabled.

Resources Controlled By

BIOS can automatically configure all the boot and Plug and Play compatible devices. If you choose Auto, you cannot select IRQ DMA and memory base address fields, since BIOS automatically assigns them.

The choice: Auto (ESCD), Manual.

IRQ Resources

When resources are controlled manually, assign each system interrupt a type, depending on the type of device using the interrupt. This item allows you to determine the IRQ assigned to the ISA bus and is not available to any PCI slot. Legacy ISA for devices compliant with the original PC AT bus specification, PCI/ISA PnP for devices compliant with the Plug and Play standard whether designed for PCI or ISA bus architecture.

Phoenix – AwardBIOS CMOS Setup Utility		
IRQ Resources		
IRQ-3 assigned to	[PCI/ISA PnP]	Item Help
IRQ-4 assigned to	[PCI/ISA PnP]	
IRQ-5 assigned to	[PCI/ISA PnP]	Menu Level ➤
IRQ-7 assigned to	[PCI/ISA PnP]	
IRQ-9 assigned to	[PCI/ISA PnP]	
IRQ-10 assigned to	[PCI/ISA PnP]	Legacy ISA for devices compliant with the original PC AT bus specification, PCI/ISA PnP for devices compliant with the Plug and Play standard whether designed for PCI or ISA bus architecture
IRQ-11 assigned to	[PCI/ISA PnP]	
IRQ-12 assigned to	[PCI/ISA PnP]	
IRQ-14 assigned to	[PCI/ISA PnP]	
IRQ-15 assigned to	[PCI/ISA PnP]	
↑↓→←: Move Enter: Select +/-/PU/PD: Value F10: Save ESC: Exit F1: General Help F5: Previous Values F6: Fail-safe Defaults F7: Optimized Defaults		

**IRQ-3/IRQ-4/IRQ-5/IRQ-7/IRQ-9/IRQ-10/IRQ-11/IRQ-12/
IRQ-14/IRQ-15 assigned to**

Legacy ISA for devices compliant with the original PC AT bus specification, PCI/ISA PnP for devices compliant with the Plug and Play standard whether designed for PCI or ISA bus architecture.

The Choice: Legacy ISA and PCI/ISA PnP.

DMA Resources

When resources are controlled manually, assign each system DMA channel a type, depending on the type of device using the DMA channel.

Phoenix – AwardBIOS CMOS Setup Utility		
DMA Resources		
DMA-0 assigned to	[PCI/ISA PnP]	Item Help
DMA-1 assigned to	[PCI/ISA PnP]	
DMA-3 assigned to	[PCI/ISA PnP]	Menu Level >
DMA-5 assigned to	[PCI/ISA PnP]	
DMA-6 assigned to	[PCI/ISA PnP]	Legacy ISA for devices compliant with the original PC AT bus specification, PCI/ISA PnP for devices compliant with the Plug and Play standard whether designed for PCI or ISA bus architecture
DMA-7 assigned to	[PCI/ISA PnP]	
↑↓→←: Move Enter: Select +/-/PU/PD: Value F10: Save ESC: Exit F1: General Help F5: Previous Values F6: Fail-safe Defaults F7: Optimized Defaults		

DMA-0/ DMA-1/ DMA-3/ DMA-5/DMA-6/ DMA-7 assigned to

Legacy ISA for devices compliant with the original PC AT bus specification, PCI/ISA PnP for devices compliant with the Plug and Play standard whether designed for PCI or ISA bus architecture.

The Choice: Legacy ISA and PCI/ISA PnP.

PCI/VGA Palette Snoop

Leave this field at *Disabled*.

The choice: Enabled, Disabled.

Assign IRQ For VGA

The choice: Enabled, Disabled.

Assign IRQ For USB

The choice: Enabled, Disabled.

PC Health Status

This section helps you to get more information about your system including CPU temperature, FAN speed and voltages. It is recommended that you contact with your motherboard supplier to get proper value about your setting of the CPU temperature.

Phoenix – AwardBIOS CMOS Setup Utility		
PC Health Status		
CPU Warning Temperature	[Disabled]	Item Help
Current System Temp .	31°C / 87°F	
Current CPUDEI Temperature	30°C / 86°F	Menu Level >
Current CPU Temperature	31°C / 87°F	
Current CPUFAN Speed	6308 RPM	
Current SYSFAN Speed	0 RPM	
Vcore :	1.12V	
+1.5V	1.53V	
+3.3V	3.48V	
+5V	5.21V	
+12V	12.46V	
-12V	-11.62V	
VBAT(V)	3.37V	
5VSB(V)	5.18V	
Shutdown Temperature	[Disabled]	
CPU Fan Control	[Enabled]	
SYSTEM Fan Control	[Enabled]	
↑↓→←: Move Enter: Select +/-/PU/PD: Value F10: Save ESC: Exit F1: General Help F5: Previous Values F6: Fail-safe Defaults F7: Optimized Defaults		

CPU Warning Temperature

Select the CPU over-heated warning temperature.

The choice: Disabled, 50°C/122°F, 53°C/127°F, 56°C/133°F, 60°C/140°F, 63°C/145°F, 66°C/151°F, 70°C/158°F.

Current System Temp.

Show System Temperature.

Current CPUDEI Temperature

Shows CPUDEI Temperature.

Current CPU Temperature

Shows Board Temperature.

Current CPUFAN Speed

Shows CPUFAN speed.

Current SYSFAN Speed

Shows SYSFAN speed.

Vcore/1.5V/3.3V/5V/12V/-12V/VBAT/5VSB Voltages

Shows Power rails voltage.

Shutdown Temperature

The choice: Disabled, 60°C/140°F, 65°C/149°F, 70°C/158°F, 75°C/167°F.

CPU Fan Control

The choice: Enabled, Disabled.

SYSTEM Fan Control

The choice: Enabled, Disabled.

Frequency/Voltage Control

Phoenix – AwardBIOS CMOS Setup Utility		
Frequency/Voltage Control		
CPU Clock Ratio	[10 X]	Item Help
Auto Detect PCI Clk	[Disabled]	
Spread Spectrum	[0.25%]	
		Menu Level >

↑↓→←: Move Enter: Select +/-/PU/PD: Value F10: Save ESC: Exit F1: General Help
F5: Previous Values F6: Fail-safe Defaults F7: Optimized Defaults

CPU Clock Ratio

The choice: Min= 4
Max= 10

Key in a DEC number:

Auto Detect PCI Clk

The choice: Enabled, Disabled.

Spread Spectrum

The choice: Disabled, 0.20%, 0.25%, 0.35%.

Load Fail-Safe Defaults

When you press <Enter> on this item you get a confirmation dialog box with a message similar to:

Load Fail-Safe Defaults (Y/N) ? N

Pressing 'Y' loads the BIOS default values for the most stable, minimal-performance system operations.

Load Optimized Defaults

When you press <Enter> on this item you get a confirmation dialog box with a message similar to:

Load Optimized Defaults (Y/N) ? N

Pressing 'Y' loads the default values that are factory settings for optimal performance system operations.

Supervisor/User Password Setting

You can set either supervisor or user password, or both of them. The differences between are:

supervisor password : can enter and change the options of the setup menus.

user password : just can only enter but do not have the right to change the options of the setup menus. When you select this function, the following message will appear at the center of the screen to assist you in creating a password.

ENTER PASSWORD:

Type the password, up to eight characters in length, and press <Enter>. The password typed now will clear any previously entered password from CMOS memory. You will be asked to confirm the password. Type the password again and press <Enter>. You may also press <Esc> to abort the selection and not enter a password.

To disable a password, just press <Enter> when you are prompted to enter the password. A message will confirm the password will be disabled. Once the password is disabled, the system will boot and you can enter Setup freely.

PASSWORD DISABLED.

When a password has been enabled, you will be prompted to enter it every time you try to enter Setup. This prevents an unauthorized person from changing any part of your system configuration.

Additionally, when a password is enabled, you can also require the BIOS to request a password every time your system is rebooted. This would prevent unauthorized use of your computer.

You determine when the password is required within the BIOS Features Setup Menu and its Security option. If the Security option is set to "System", the password will be required both at boot and at entry to Setup. If set to "Setup", prompting only occurs when trying to enter Setup.

Exit Selecting

Save & Exit Setup

Pressing <Enter> on this item asks for confirmation:

Save to CMOS and EXIT (Y/N)? Y

Pressing “Y” stores the selections made in the menus in CMOS – a special section of memory that stays on after you turn your system off. The next time you boot your computer, the BIOS configures your system according to the Setup selections stored in CMOS. After saving the values the system is restarted again.

Exit Without Saving

Pressing <Enter> on this item asks for confirmation:

Quit without saving (Y/N)? N

This allows you to exit Setup without storing in CMOS any change. The previous selections remain in effect. This exits the Setup utility and restarts your computer.

CHAPTER 4 Appendix

I/O Port Address Map.....	80
Interrupt Request Lines(IRQ)	81
POST Beep	82

A. I/O Port Address Map

Each peripheral device in the system is assigned a set of I/O port addresses which also becomes the identity of the device. There are a total of 1K port address space available. The following table lists the I/O port addresses used on the Industrial CPU Card.

Address	Device Description
000h - 01Fh	DMA Controller #1
020h - 03Fh	Interrupt Controller #1
040h - 05Fh	Timer
060h - 06Fh	Keyboard Controller
070h - 07Fh	Real Time Clock, NMI
080h - 09Fh	DMA Page Register
0A0h - 0BFh	Interrupt Controller #2
0C0h - 0DFh	DMA Controller #2
0F0h	Clear Math Coprocessor Busy Signal
0F1h	Reset Math Coprocessor
1F0h - 1F7h	IDE Interface
278 - 27F	Parallel Port #2(LPT2)
2F8h - 2FFh	Serial Port #2(COM2)
2B0 - 2DF	Graphics adapter Controller
378h - 3FFh	Parallel Port #1(LPT1)
360 - 36F	Network Ports
3B0 - 3BF	Monochrome & Printer adapter
3C0 - 3CF	EGA adapter
3D0 - 3DF	CGA adapter
3F0h - 3F7h	Floppy Disk Controller
3F8h - 3FFh	Serial Port #1(COM1)

B. Interrupt Request Lines (IRQ)

There are a total of 15 IRQ lines available on the Industrial CPU Card. Peripheral devices use interrupt request lines to notify CPU for the service required. The following table shows the IRQ used by the devices on the Industrial CPU Card.

Level	Function
IRQ0	System Timer Output
IRQ1	Keyboard
IRQ2	Interrupt Cascade
IRQ3	Serial Port #2
IRQ4	Serial Port #1
IRQ5	Reserved
IRQ6	Floppy Disk Controller
IRQ7	Parallel Port #1
IRQ8	Real Time Clock
IRQ9	Software Redirected to Int 0Ah
IRQ10	Reserved
IRQ11	Reserved
IRQ12	PS/2 Mouse
IRQ13	80287
IRQ14	Primary IDE
IRQ15	Secondary IDE

C. POST Beep

Currently there are two kinds of beep codes in BIOS. This code indicates that a **video error** has occurred and the BIOS cannot initialize the video screen to display any additional information. This beep code consists of a single long beep followed by two short beeps.

The other code indicates that your **DRAM error** has occurred. This beep code consists of a single long beep repeatedly.